

BD-D5300
BD-D5250C

Blu-ray™ Disc Player

user manual

imagine the possibilities

Thank you for purchasing this Samsung product.
To receive more complete service,
please register your product at
www.samsung.com/register



Key features

Blu-ray Disc Features

Blu-ray Discs support the highest quality HD video available in the industry - Large capacity means no compromise on video quality.

The following Blu-ray Disc features are disc dependant and will vary.

Appearance and navigation of features will also vary from disc to disc.

Not all discs will have the features described below.

Video highlights

The BD-ROM format supports three highly advanced video codecs, including AVC, VC-1 and MPEG-2.

HD video resolutions are also supported:

- 1920 x 1080 High Definition
- 1280 x 720 High Definition

For High-Definition Playback

To view high-definition contents on a Blu-ray Disc, you need an HDTV (High Definition Television).

Some Blu-ray Discs may require you to use the player's HDMI OUT to view high-definition content.

The ability to view high-definition content on Blu-ray Discs may be limited depending on the resolution of your TV.

BD-LIVE

You can use a Blu-ray Disc that supports BD-LIVE to download content provided by the disc manufacturer through a network connection.

Blu-ray Disc Player Features

Smart Hub

You can download various for pay or free-of-charge applications through a network connection. These applications provide a range of Internet services and content including news, weather forecasts, stock market quotes, games, movies, and music.

AllShare

You can play videos, music, and photos saved on your devices (such as your PC, mobile phones, or NAS) through a network connection.

Playing multimedia files

You can use the USB connection to play various kinds of multimedia files (MP3, JPEG, DivX, etc.) located from a USB storage device.

Safety Information

Warning

TO REDUCE THE RISK OF ELECTRIC SHOCK, DO NOT REMOVE THE COVER (OR BACK). NO USER-SERVICEABLE PARTS ARE INSIDE. REFER SERVICING TO QUALIFIED SERVICE PERSONNEL.

	CAUTION RISK OF ELECTRIC SHOCK DO NOT OPEN	
The lightning flash and Arrowhead within the triangle is a warning sign alerting you of dangerous voltage inside the product.	CAUTION: TO REDUCE THE RISK OF ELECTRIC SHOCK, DO NOT REMOVE COVER (OR BACK) NO USER SERVICEABLE PARTS INSIDE. REFER SERVICING TO QUALIFIED SERVICE PERSONNEL.	The explanation point within the triangle is a warning sign alerting you of important instructions accompanying the product.

WARNING

- To reduce the risk of fire or electric shock, do not expose this appliance to rain or moisture.

FCC NOTE (for U.S.A)

This equipment has been tested and found to comply with the limits for a Class B digital device, pursuant to Part 15 of the FCC rules. These limits are designed to provide reasonable protection against harmful interference in a residential installation. This equipment generates, uses and can radiate radio frequency energy and, if not installed and used in accordance with the instructions, may cause harmful interference to radio or television reception, which can be determined by turning the equipment off and on.

The user is encouraged to try to correct the interference by one or more of the following measures.

- Reorient or relocate the receiving antenna.
- Increase the separation between the equipment and receiver.
- Connect this equipment into an outlet on a circuit different from that to which the receiver is connected.
- Consult the dealer or an experienced radio/TV technician for help.
- This class B digital product meets all requirements of the Canadian Interference - Causing Equipment Regulations.

Note to CATV system installer

This reminder is provided to call CATV system installer's attention to Article 820-40 of the National Electrical Code (Section 54 of Canadian Electrical Code, Part I) that provides guidelines for proper grounding and, in particular, specifies that the cable ground shall be connected to the grounding system of the building as close to the point of cable entry as practical.

CLASS 1 LASER PRODUCT

This Compact Disc player is classified as a CLASS 1 LASER product. Use of controls, adjustments or performance of procedures other than those specified herein may result in hazardous radiation exposure.

Complies with 21CFR 1040.10 except for deviations pursuant to Laser Notice No. 50, dated June 24, 2007.

DANGER :

- VISIBLE AND INVISIBLE LASER RADIATION WHEN OPEN. AVOID DIRECT EXPOSURE TO BEAM. (FDA 21 CFR)

CAUTION :

- CLASS 3B VISIBLE AND INVISIBLE LASER RADIATION WHEN OPEN. AVOID EXPOSURE TO THE BEAM (IEC 60825-1)
- THIS PRODUCT UTILIZES A LASER. USE OF CONTROLS OR ADJUSTMENTS OR PERFORMANCE OF PROCEDURES OTHER THAN THOSE SPECIFIED HEREIN MAY RESULT IN HAZARDOUS RADIATION EXPOSURE. DO NOT OPEN COVER AND DO NOT REPAIR YOURSELF. REFER SERVICING TO QUALIFIED PERSONNEL.

CLASS 1 LASER PRODUCT
KLASSE 1 LASER PRODUKT
LUOKAN 1 LASER LAITE
KLASS 1 LASER APPARAT
PRODUCTO LÁSER CLASE 1

NOTE

- If the Region number of a Blu-ray Disc/DVDs disc does not correspond to the Region number of this player, the player cannot play the disc.

Safety Information

Precautions

Important Safety Instructions

Read these operating instructions carefully before using the unit. Follow all the safety instructions listed below.

Keep these operating instructions handy for future reference.

1. Read these instructions.
2. Keep these instructions.
3. Heed all warnings.
4. Follow all instructions.
5. Do not use this apparatus near water.
6. Clean only with a dry cloth.
7. Do not block any ventilation openings. Install in accordance with the manufacturer's instructions.
8. Do not install near any heat sources such as radiators, heat registers, stoves, or other apparatus (including AV receivers) that produce heat.
9. Do not defeat the safety purpose of the polarized or grounding-type plug. A polarized plug has two blades with one wider than the other. A grounding type plug has two blades and a third grounding prong. The wide blade or the third prong are provided for your safety. If the provided plug does not fit into your outlet, consult an electrician for replacement of the obsolete outlet.
10. Protect the power cord from being walked on or pinched particularly at plugs, convenience receptacles, and the point where they exit from the apparatus.
11. Only use attachments/accessories specified by the manufacturer.
12. Use only with the cart, stand, tripod, bracket, or table specified by the manufacturer, or sold with the apparatus. When a cart is used, use caution when moving the cart/apparatus combination to avoid injury from tip-over.



13. Unplug this apparatus during lightning storms or when unused for long periods of time.
14. Refer all servicing to qualified service personnel. Servicing is required when the apparatus has been damaged in any way, such as power-supply cord or plug is damaged, liquid has been spilled or objects have fallen into the apparatus, the apparatus has been exposed to rain or moisture, does not operate normally, or has been dropped.

Disc Storage & Management

Disc Handling

Disc Shape

- Use discs with regular shapes. If you use an irregular disc (a disc with a special shape), you can damage the player.



Holding discs

- Avoid touching the surface of a disc where data has been recorded.



Blu-ray Discs

- Do not leave a Blu-ray Disc in the player for long periods of time. Remove the Blu-ray Disc from the player and store it in its case.
- Be careful not to scratch or leave fingerprints on the surface of the Blu-ray Disc.

DVD-VIDEO, Audio CD (CD-DA)

- Wipe off dirt or contamination on the disc with a soft cloth.

Disc Storage

Be careful not to damage the disc because the data on these discs is highly vulnerable to the environment.

- Do not keep under direct sunlight.
- Keep in a cool ventilated area.
- Store vertically.
- Keep in a clean protection jacket.
- If you move your player suddenly from a cold place to a warm place, condensation may occur on the operating parts and lens and cause abnormal disc playback. If this occurs, unplug the player, wait for two hours, and then connect the plug to the power outlet. Then, insert the disc, and try to play back again.

Handling Cautions

- Do not write on the printed side with a ball-point pen or pencil.
- Do not use record cleaning sprays or antistatic sprays to clean discs. Also, do not use volatile chemicals, such as benzene or thinner.
- Do not apply labels or stickers to discs. (Do not use discs fixed with exposed tape adhesive or leftover peeled-off stickers.)
- Do not use scratch-proof protectors or covers.
- Do not use discs printed with label printers available on the market.
- Do not load warped or cracked discs.
- Before connecting other components to this player, be sure to turn them off.
- Do not move the player while it is playing a disc. The disc can be scratched or damaged and the player's internal parts can be damaged.
- Do not put a flower vase filled with water or any small metal objects on the player.
- Be careful not to put your hand into the disc tray.
- Do not place anything other than the disc in the disc tray.
- Interference from exterior sources such as lightening and static electricity can affect the normal operation of this player. If this occurs, turn the player off and on again with the **POWER** button, or disconnect and then reconnect the AC power cord to the AC power outlet. The player will operate normally.

- Be sure to remove the disc and turn off the player after use.
- Disconnect the AC power cord from the AC outlet when you don't intend to use the player for long periods of time.
- To clean a disc, wipe it in a straight line from the inside to the outside of the disc.
- Do not expose the player to any liquid.
- When the AC plug is connected to a wall outlet, the player will still draw power (standby mode) when it is turned off.
- Apparatus shall not be exposed to dripping or splashing and no objects filled with liquids, such as vases, shall be placed on the apparatus.
- The main plug is used as a disconnect device and shall stay readily operable at any time.



Maintenance of Cabinet

Before you clean the Blu-ray Disc's cabinet, be sure to disconnect the AC power cord from the AC outlet.

- Do not use benzene, thinner, or other solvents for cleaning.
- Wipe the cabinet with a soft cloth.

Restrictions on Playback

- This player may not respond to all operating commands because some Blu-ray Disc, DVD, and CD discs allow specific or limited operation and provide only certain features during playback. Please note that this is not a defect in the player.
- Samsung cannot guarantee that this player will play every disc bearing the Blu-ray Disc, DVD or CD logo because disc formats evolve, and problems and errors may occur during the creation of Blu-ray Disc, DVD, and CD software and/or the manufacture of discs. Please contact the SAMSUNG customer care center if you have questions or encounter difficulty in playing Blu-ray Disc, DVD, or CD discs in this player. Also, refer to rest of this user manual for additional information on playback restrictions.

Contents

KEY FEATURES

- 2 **Blu-ray Disc Features**
- 2 **Blu-ray Disc Player Features**

SAFETY INFORMATION

- 3 **Warning**
- 4 **Precautions**
- 4 Important Safety Instructions
- 4 **Disc Storage & Management**
- 4 Disc Handling

GETTING STARTED

- 10 **Before using the User Manual**
- 10 Disc Types and Contents your player can play
- 10 Disc types your player cannot play
- 11 Blu-ray Disc Compatibility
- 11 Disc Types
- 12 Region Code
- 12 Copyright
- 13 Supported File Formats
- 14 Logos of Discs the player can play
- 14 **Accessories**
- 15 **Front Panel**
- 16 **Rear Panel**
- 17 **Remote Control**
- 17 Tour of the Remote Control

CONNECTIONS

- 18 **Connecting to a TV**
- 18 Case 1 : Connecting to a TV with an HDMI Cable
- Best Quality (Recommended)
- 19 Case 2 : Connecting to a TV with an Audio/Video
cable - Good Quality

CONNECTIONS

- 20 **Connecting to an Audio System**
- 20 Case 1 : Connecting to an Audio System
(HDMI supported AV receiver) - Best Quality
(Recommended)
- 21 Case 2 : Connecting to an Audio System
(AV receiver with Dolby Digital or DTS decoder) -
Better Quality
- 21 Case 3 : Connecting to an Audio System
(Stereo Amplifier) - Good Quality
- 22 **Connecting to the Network**
- 22 Cable Network
- 23 Wireless Network

SETUP

- 24 **Initial Settings**
- 25 **Accessing the Settings Menu**
- 26 **Display**
- 26 TV Aspect
- 26 Smart Hub Screen Size
- 26 BD Wise (Samsung Players only)
- 26 Resolution
- 28 HDMI Color Format
- 28 Movie Frame (24Fs)
- 28 HDMI Deep Color
- 28 Still Mode
- 28 Progressive Mode
- 28 **Audio**
- 28 Digital Output
- 30 PCM Downsampling
- 30 Dynamic Range Control
- 30 Downmixing Mode
- 31 **Network**
- 31 Network Settings
- 34 Network Status
- 35 BD-LIVE Internet Connection

Contents

SETUP

- 35 **System**
- 35 Initial Settings
- 35 Anynet+(HDMI-CEC)
- 35 BD Data Management
- 36 Time Zone
- 36 DivX® Video On Demand
- 36 Reset
- 36 **Language**
- 36 **Security**
- 36 BD Parental Rating
- 36 DVD Parental Rating
- 36 Change Password
- 37 **General**
- 37 Front Display
- 37 Network Remote Control
- 37 **Support**
- 37 Software Upgrade
- 39 Contact Samsung

BASIC FUNCTIONS

- 40 **Playing a Video**
- 40 Playback
- 40 Disc Structure
- 40 **Using the Disc Menu/Title Menu/Popup Menu**
- 40 Using the Disc Menu
- 41 Using the Title Menu
- 41 Playing the Title List
- 41 Using the Popup Menu
- 41 **Using the Search and Skip Functions**
- 41 Searching for a Desired Scene
- 41 Skipping Chapters
- 42 **Slow Motion Play/Step Motion Play**
- 42 Slow Motion Play
- 42 Step Motion Play

BASIC FUNCTIONS

- 42 **Using the TOOLS button**
- 42 Moving to a Desired Scene Directly
- 42 Repeating the Title or Chapter
- 43 Repeating a Section
- 43 Changing to Full Screen
- 43 Selecting the Picture Settings
- 43 Selecting the Audio Language
- 44 Selecting the Subtitle Language
- 44 Changing the Camera Angle
- 44 Setting BONUSVIEW
- 45 **Listening to Music**
- 45 Buttons on the Remote Control used for Music Playback
- 45 Playing an Audio CD (CD-DA)/MP3
- 46 Repeat an Audio CD (CD-DA)/MP3
- 46 Playlist
- 47 **Playing back Pictures**
- 47 Playing a JPEG files
- 47 Using the TOOLS button
- 48 **Playing back a USB Storage Device**

NETWORK SERVICES

- 49 **Using Smart Hub**
- 49 Starting Smart Hub for the First Time
- 52 The Settings Menu - BLUE (D)
- 54 The Edit Mode Menu - YELLOW (C)
- 56 The Sort Menu - GREEN (B)
- 56 **Samsung Apps**
- 56 For Pay Apps
- 58 **BD-LIVE™**
- 58 **Using the AllShare Function**

APPENDIX

- 59 **Troubleshooting**
- 61 Repairs
- 62 **Index**
- 63 **Specifications**

Getting Started

Before using the User Manual

Disc Types and Contents your player can play

Content	Logo	Icon	Definition
VIDEO		 	Indicates a function available on a BD-ROM or BD-RE/-R disc recorded in the BD-RE format.
	     	 	Indicates a function available on a DVD-VIDEO or recorded DVD+RW/DVD-RW(V)/DVD-R/+R discs that have been recorded and finalized.
	-		Indicates a function available in a CD-RW/-R, DVD-RW/-R, BD-RE/-R disc or a USB storage media containing DivX, MKV, MP4 contents.
MUSIC			Indicates a function available on an audio CD-RW/-R (CD-DA format).
	-		Indicates a function available in a CD-RW/-R, DVD-RW/-R, BD-RE/-R disc or a USB storage media containing MP3 or WMA contents.
PHOTO	-		Indicates a function available in a CD-RW/-R, DVD-RW/-R, BD-RE/-R disc or a USB storage media containing JPEG contents.

NOTE

- The player may not play certain CD-RW/-R and DVD-R because of the disc type or recording conditions.
- If a DVD-RW/-R disc has not been recorded properly in DVD video format, it will not be playable.
- Your player will not play content that has been recorded on a DVD-R at a bit-rate that exceeds 10 Mbps.
- Your player will not play content that has been recorded on a BD-R or USB device at a bit rate that exceeds 30 Mbps.

Disc types your player cannot play

- HD DVD
- DVD-ROM/PD/MV-Disc, etc
- DVD-RAM
- Super Audio CD (except CD layer)
- DVD-RW(VR mode)
- CVD/CD-ROM/CDV/CD-G/CD-I/LD (CD-Gs play audio only, not graphics.)
- 3.9 GB DVD-R Disc for Authoring.

 **NOTE**

- Some commercial discs and DVDs discs purchased outside your region may not play on this player.
- Playback may not work for some types of discs, or when you use specific operations, such as angle change and aspect ratio adjustment. Information about the discs is written in detail on the disc box. Please refer to this if necessary.
- Do not allow the disc to become dirty or scratched. Fingerprints, dirt, dust, scratches or deposits of cigarette smoke on the recording surface may make it impossible to use the disc for playback.
- Discs with PAL programs recorded on them cannot be played using this player.
- This player is compatible with the NTSC color system only.
- When you play a BD-J title, loading may take longer than a normal title or some functions may perform slowly.
- This player may not respond to all operating commands because some Blu-ray Disc, DVD, and CD discs allow specific or limited operation and provide only certain features during playback. Please note that this is not a defect in the player.
- Samsung cannot guarantee that this player will play every disc bearing the Blu-ray Disc, DVD or CD logo because disc formats evolve, and problems and errors may occur during the creation of Blu-ray Disc, DVD, and CD software and/or the manufacture of discs.
Please contact the SAMSUNG customer care center if you have questions or encounter difficulty when playing Blu-ray Disc, DVD, or CD discs in this player. Also, refer to rest of this user manual for additional information on playback restrictions.

Blu-ray Disc Compatibility

Blu-ray Disc is a new and evolving format. Accordingly, disc compatibility issues are possible. Not all discs are compatible and not every disc will play back. For additional information, refer to the Compliance and Compatibility Notice section of this user manual.

Disc Types

BD-ROM

Blu-ray ROM discs can only be played back. This player can play back pre-recorded commercial BD-ROM discs.

BD-RE/-R

Blu-ray RE/-R discs can be recorded on and played back. This player can play back a BD-RE/-R disc recorded by other compatible Blu-ray Disc recorders.

DVD-VIDEO

- This player can play back pre-recorded commercial DVDs (DVD-VIDEO discs) with movies.
- When switching from the first layer to the second layer of a dual-layered DVD-VIDEO disc, there may be momentary distortion in the image and sound. This is not a malfunction of the player.

DVD-RW/-R/+R

This player can play back a DVD-RW/-R/+R disc recorded and finalized with a DVD video recorder. The ability to play back may depend on recording conditions.

DVD+RW

- This player can play back a DVD+RW disc recorded with a DVD Video recorder. The ability to play back may depend on recording conditions.

Audio CD (CD-DA)

- This player can play back CD-DA format audio CD-RW/-R discs.
- The player may not be able to play some CD-RW/-R discs due to the condition of the recording.

Getting Started

CD-RW/-R

- Use a 700MB (80 minute) CD-RW/-R disc. If possible, do not use an 800MB (90 minute) or larger disc, as the disc may not play back.
- If the CD-RW/-R disc was not recorded as a closed session, you may experience delays when playing back the beginning of the disc or all recorded files may not play.
- Some CD-RW/-R discs may not play on this player, depending on the device which was used to burn them. For contents recorded on CD-RW/-R media from CDs for your personal use, playability may vary depending on the contents and discs.

AVCHD (Advanced Video Codec High Definition)

- This player can play back AVCHD format discs. These discs are normally recorded and used in camcorders.
- The AVCHD format is a high definition digital video camera format.
- The MPEG-4 AVC/H.264 format compresses images with greater efficiency than the conventional image compressing format.
- Some AVCHD discs use the “x.v.Color” format. This player can play back AVCHD discs that use “x.v.Color” format.
- “x.v.Color” is a trademark of Sony Corporation.
- “AVCHD” and the AVCHD logo are trademarks of Matsushita Electronic Industrial Co., Ltd. and Sony Corporation.

NOTE

- Some AVCHD format discs may not play, depending on the recording condition. AVCHD format discs need to be finalized.
- “x.v.Color” offers a wider color range than normal DVD camcorder discs.
- Some DivX, MKV and MP4 format discs may not play, depending on the video resolution and frame rate condition.

Region Code

Both players and discs are coded by region. These regional codes must match for a disc to play. If the codes do not match, the disc will not play. The Region Number for this player is displayed on the rear panel of the player.

Disc Type	Region Code	Area
Blu-ray Disc		North America, Central America, South America, Korea, Japan, Taiwan, Hong Kong and South East Asia.
		Europe, Greenland, French territories, Middle East, Africa, Australia and New Zealand.
		India, China, Russia, Central and South Asia.
DVD-VIDEO		The U.S., U.S. territories and Canada
		Europe, Japan, the Middle East, Egypt, South Africa, Greenland
		Taiwan, Korea, the Philippines, Indonesia, Hong Kong
		Mexico, South America, Central America, Australia, New Zealand, Pacific Islands, Caribbean
		Russia, Eastern Europe, India, most of Africa, North Korea, Mongolia
		China

Copyright

© 2011 Samsung Electronics Co.,Ltd.
All rights reserved; No part or whole of this user's manual may be reproduced or copied without the prior written permission of Samsung Electronics Co.,Ltd.

Supported File Formats

Notes on the USB connection

- Your player supports USB storage media, MP3 players, digital cameras, and USB card readers.
- The player does not support folder or file names longer than 128 characters.
- Some USB/digital camera devices may not be compatible with the player.
- Your player supports the FAT16, FAT32, and NTFS files systems.
- Connect USB devices directly to the player's USB port. Connecting through a USB cable may cause compatibility problems.
- Inserting more than one memory device into a multi-card reader may cause the reader to operate improperly.
- The player does not support the PTP protocol.
- Do not disconnect a USB device during a "loading" process.
- The bigger the image resolution, the longer the image takes to display.
- This player cannot play MP3 files with DRM (Digital Rights Management) downloaded from commercial sites.
- External HDD device is not supported.
- Your player only supports the video that is under 30fps (frame rate).

Video File Support

File Extension	Container	Video Codec	Audio Codec	Resolution
*.avi	AVI	DivX 3.11/4.x/5.1/6.0	MP3 AC3 DTS WMA PCM	1920x1080
		MP4v3		1920x1080
		H.264 BP/MP/HP		1920x1080
*.mkv	MKV	VC-1 AP	MP3 AC3 DTS	1920x1080
		DivX 5.1/6.0		1920x1080
		H.264 BP/MP/HP		1920x1080
*.wmv	WMV (wmv9)	VC-1 AP	WMA	1920x1080
		VC-1 SM		1920x1080
*.mp4	MP4	MP4 (mp4v)	AAC	1920x1080
		H.264 BP/MP/HP		1920x1080
*.mpg *.mpeg	PS	MPEG1	MP1, 2 AC3 DTS	1920x1080
		MPEG2		1920x1080
		H.264 BP/MP/HP		1920x1080
*.ts *.tp *.trp	TS	MPEG2	AC3 AAC MP3 DD+ HE-AAC	1920x1080
		H.264		1920x1080
		VC-1		1920x1080

Getting Started

Music File Support

File Extension	Container	Audio Codec	Support Range
*.mp3	MP3	MP3	-
*.wma	WMA	WMA	Compliant with WMA version 10 * Sampling rates (in kHz) - 8, 11, 16, 22, 32, 44.1, 48 * Bit rates - All bit-rates in the range 5kbps to 384kbps

Logos of Discs the player can play

			
Blu-ray Disc	DTS-HD Master Audio	DivX	BD-LIVE
			
Dolby TrueHD	NTSC broadcast system in U.S.A, Canada, Korea, Japan		Java

Accessories

Check for the supplied accessories below.

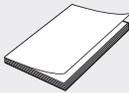
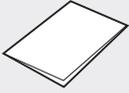
		
HDMI cable (MF39-00299A) (Only for BD-D5250C)	Audio/Video cable (AC39-00073A)	Batteries for Remote Control (AAA Size) (AC43-12002H)
		
User Manual (AK68-01984A)	Quick Guide (AK68-01985A)	Remote Control (AK59-00113A)

Front Panel

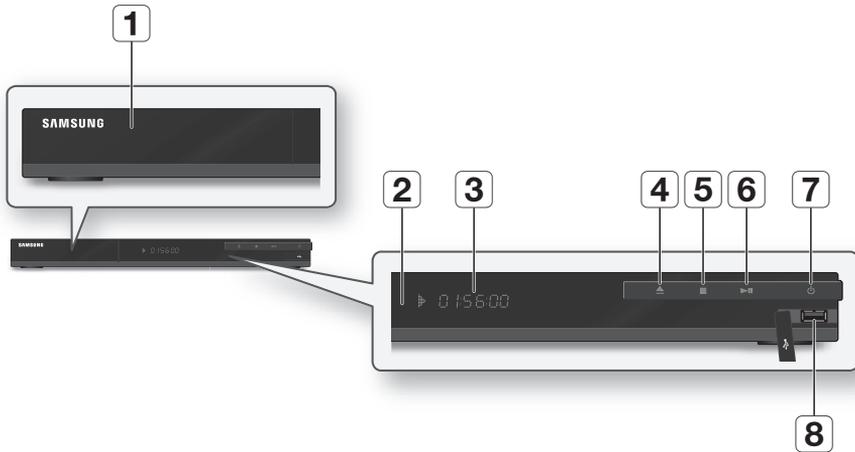

1	DISC TRAY	Opens to accept a disc.
2	REMOTE CONTROL SENSOR	Detects signals from the remote control.
3	DISPLAY	Displays the playing status, time, etc.
4	OPEN/CLOSE BUTTON	Opens and closes the disc tray.
5	STOP BUTTON	Stops disc playback.
6	PLAY/PAUSE BUTTON	Plays a disc or pauses playback. (It may not play a Blu-ray Disc.)
7	POWER BUTTON	Turns the player on and off.
8	USB HOST	You can connect a USB memory flash stick here and use it as storage when the player is connected to BD-LIVE. You can also use the USB Host for software upgrades and MP3/JPEG/DivX/MKV/MP4 playback.

NOTE

- You can perform software upgrades using the USB Host jack with a USB memory flash stick only.
- When the player displays the Blu-ray Disc menu, you cannot start the movie by pressing the Play button on the player or the remote. To play the movie, you must select Play Movie or Start in the disc menu, and then press the **ENTER** button.

Getting Started

Rear Panel

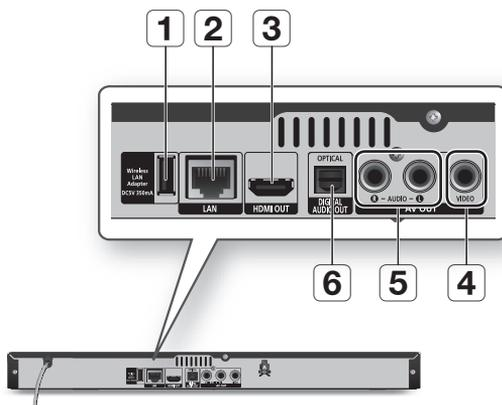

1	WIRELESS LAN ADAPTER	Connect the optional Wireless LAN Adapter (WIS09ABGN) here to use a Wireless network.
2	LAN	Use for network based services (See pages 49~58), BD-LIVE, and software upgrades using a network connection.
3	HDMI OUT	Using an HDMI cable, connect this HDMI output terminal to the HDMI input terminal on your TV for the best quality picture or to your AV receiver for the best quality sound.
4	VIDEO OUT	Connects to the video input of external devices using a video cable.
5	AUDIO OUT	Connects to the audio input of external devices using audio cables.
6	DIGITAL AUDIO OUT	Connects to a AV receiver.

Remote Control

Tour of the Remote Control



Installing batteries

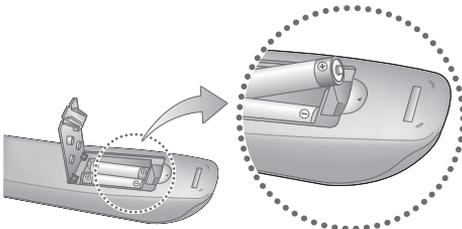

NOTE

- If the remote does not operate properly:
 - Check the polarity +/- of the batteries.
 - Check if the batteries are drained.
 - Check if the remote sensor is blocked by obstacles.
 - Check if there is any fluorescent lighting nearby.

! CAUTION

- Dispose of batteries according to local environmental regulations. Do not put them in the household trash.

Connections

Connecting to a TV

Case 1 : Connecting to a TV with an HDMI Cable - Best Quality (Recommended)

1. Using an HDMI cable, connect the **HDMI OUT** terminal on the rear of the player to the **HDMI IN** terminal of your TV.
2. Turn on the player and TV.
3. Press the input selector on your TV remote control until the HDMI signal from the player appears on your TV screen.

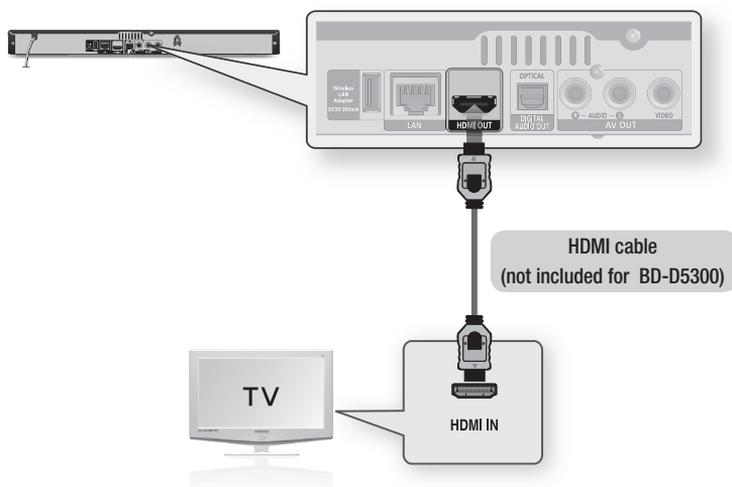

NOTE

- An HDMI cable outputs digital video/audio, so you don't need to connect an audio cable.
- If the player is connected to your TV in the HDMI 720p, 1080i, or 1080p output mode, you must use a High speed (category 2) HDMI cable.
- HDMI outputs only a pure digital signal to the TV.
If your TV does not support HDCP (High-bandwidth Digital Content Protection), random noise appears on the screen.
- Depending on your TV, certain HDMI output resolutions may not work. Please refer to the user manual of your TV.
- When you connect the player to the TV using the HDMI cable for the first time or to a new TV, the HDMI output resolution will be automatically set to the highest supported by the TV.
- A long HDMI cable may cause a screen noise. If this occurs, set Deep Color to Off in the menu.
- If you use HDMI-to-DVI cable to connect to your display device, you must also connect the AV Out or Digital Audio Out to your display device or an audio system to hear audio.
- If both HDMI and Video out are connected at the same time, only the HDMI signal is outputted.

Case 2 : Connecting to a TV with an Audio/Video cable - Good Quality

1. Using an Audio/Video cable, connect the **VIDEO OUT (yellow)** / **AUDIO OUT (red and white)** terminals on the rear of the player to the **VIDEO IN (yellow)** / **AUDIO IN (red and white)** terminals of your TV.
2. Turn on the player and TV.
3. Press the input selector on your TV remote control until the "VIDEO" signal from the player appears on the TV screen.

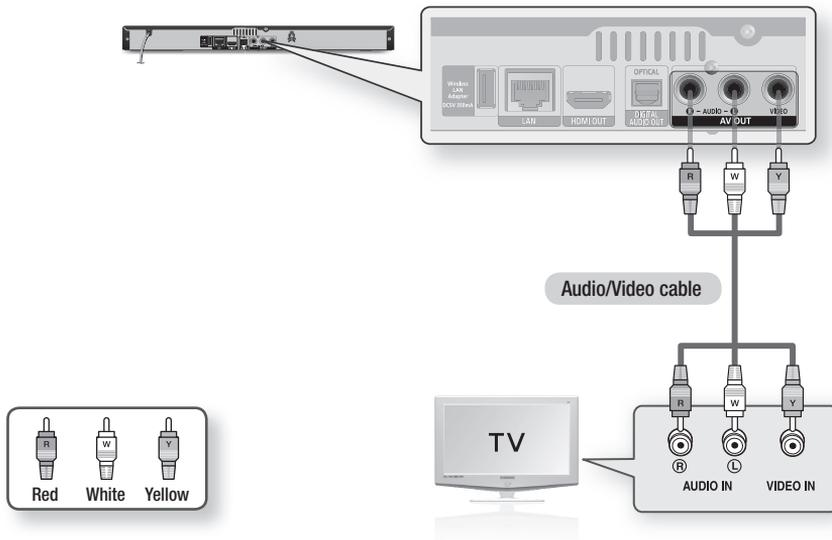

NOTE

- Noise may be generated if the audio cable is placed too close to the power cable.
- If you want to connect to an AV receiver, please refer to the AV receiver connection pages. (See pages 20~21)
- The number and position of the input terminals may vary depending on your TV set. Please refer to the user manual of your TV.

! CAUTION

- Do not connect the player to your TV through a VCR. Video signals fed through VCRs may be affected by copyright protection systems and the picture will be distorted on the television.

Connections

Connecting to an Audio System

- Please turn the volume down when you turn on the AV receiver. A sudden loud sound may cause damage to the speakers and your ears.
- Please set the audio format according to the capabilities of your AV receiver. (See pages 28~30)
- The position of HDMI input terminals may vary depending on your AV receiver. Please refer to the user manual of your AV receiver.

Case 1 : Connecting to an Audio System (HDMI supported AV receiver) - Best Quality (Recommended)

1. Using an HDMI cable, connect the **HDMI OUT** terminal on the rear of the player to the **HDMI IN** terminal of your AV receiver.
2. Using an HDMI cable, connect the **HDMI OUT** terminal of the AV receiver to the **HDMI IN** terminal of your TV.
3. Turn on the player, TV, and AV receiver.
4. Press the input select button of the AV receiver and TV to select the external input to hear sound from the player. Refer to your AV receiver's user manual to set the AV receiver's audio input.

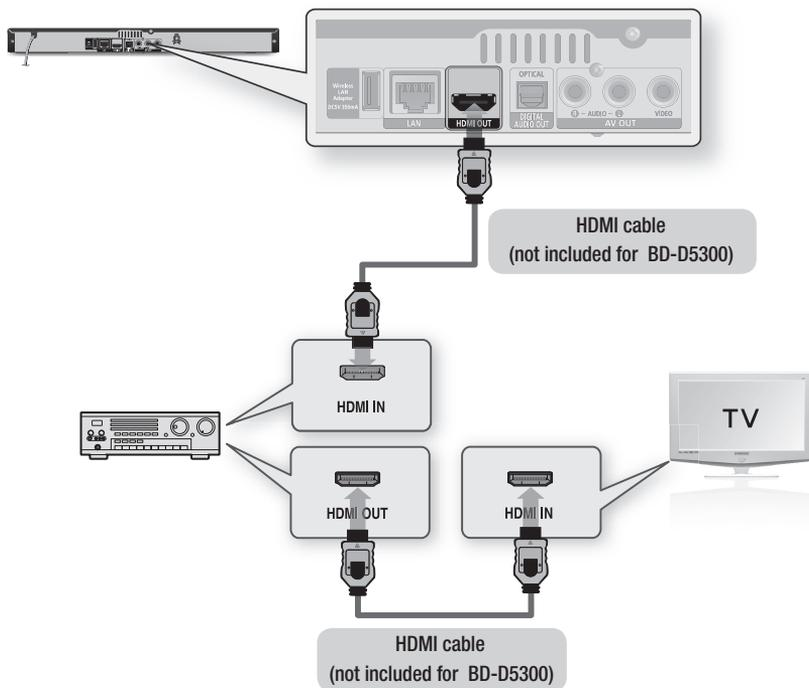

Case 2 : Connecting to an Audio System (AV receiver with Dolby Digital or DTS decoder) - Better Quality

1. Using an optical cable, connect the **DIGITAL AUDIO OUT (OPTICAL)** terminal on the rear of the player to the **DIGITAL AUDIO IN (OPTICAL)** terminal of your AV receiver.
2. Using the video signal cable(s), connect the **HDMI** or **VIDEO OUT** terminals on the rear of the player to the **HDMI** or **VIDEO IN** terminal of your TV. (See pages 18~19)
3. Turn on the player, TV, and AV receiver.
4. Press the input select button of the AV receiver to select the external input and hear sound from the player. Refer to your AV receiver's user manual to set the AV receiver's audio input.
5. Press the input selector on your TV remote control to select the video source (HDMI or Video.)

Case 3 : Connecting to an Audio System (Stereo Amplifier) - Good Quality

1. Using the audio cables, connect the **AUDIO OUT (red and white)** terminals on the rear of the player to the **AUDIO IN (red and white)** terminals of your Stereo Amplifier.
2. Using the video signal cable(s), connect the **HDMI** or **VIDEO OUT** terminals on the rear of the player to the **HDMI** or **VIDEO IN** terminal of your TV. (See pages 18~19)
3. Turn on the player, TV and Stereo Amplifier
4. Press the input select button of the Stereo Amplifier to select the external input in order to hear sound from the player. Refer to your Stereo Amplifier's user manual to set the Stereo Amplifier's audio input.
5. Press the input selector on your TV remote control to select the video source (HDMI or Video.)

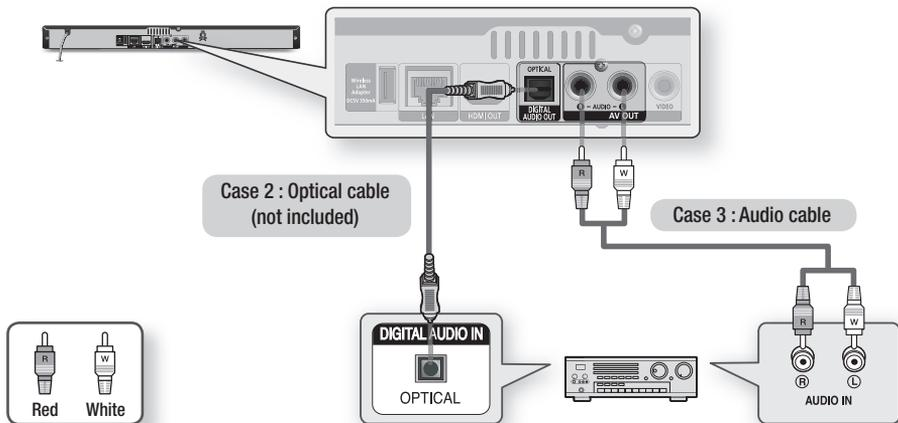

NOTE

- If you use the Digital Audio connection described in Case 2, you will hear only front two speakers with Digital Output setting as PCM.

Connections

Connecting to the Network

This player lets you use network based services (See pages 49~58) such as Smart Hub and BD-LIVE, and download software upgrades when it is connected to a network. We recommend using an AP (Access Point) or IP router for the connection. For more information on router connections, refer to the user manual of the router or contact the router manufacturer for technical assistance.

Cable Network

1. Using the Direct LAN Cable (UTP cable), connect the LAN terminal of the player to the LAN terminal of your modem or router.
2. Set the network options. See pages 31~35

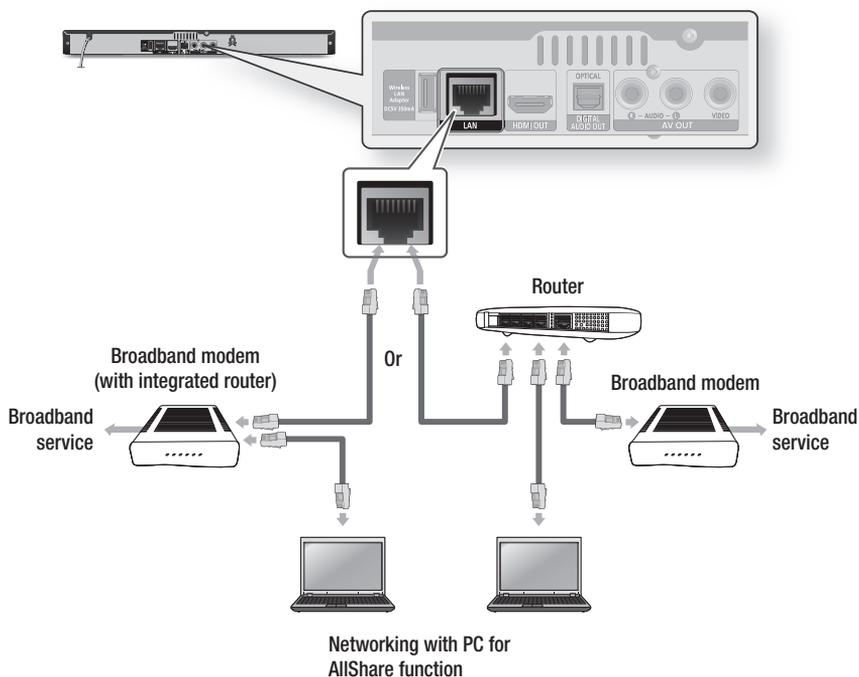

NOTE

- Internet access to Samsung's software update server may not be allowed, depending on the router you use or your ISP's policy. For more information, contact your ISP (Internet Service Provider).
- For DSL users, please use a router to make a network connection.
- To use the AllShare function, you must connect your PC to your network as shown in the figure. The connection can be wired or wireless.

Wireless Network

You can connect to network with a Wireless IP sharer (a router or a modem).

1. A wireless AP/IP router and the Samsung Wireless LAN Adapter is required to make a wireless network connection. Connect the Wireless LAN adapter (not included) to the Wireless LAN Adapter jack on the rear panel of the player. See the diagram below.
2. To Set the network options. See pages 31~35.

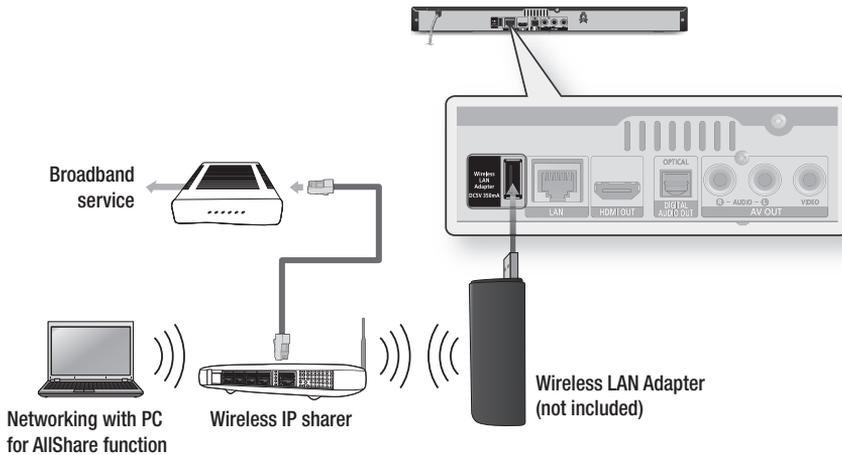

NOTE

- Use only the Samsung wireless LAN adapter with this player. (Model name : WIS09ABGN). Do not use this wireless adapter with any third-party players. To purchase the Samsung wireless LAN adapter, visit your Samsung retailer.
- You must use a wireless IP sharer that supports IEEE 802.11 a/b/g/n. (n is recommended for stable operation of the wireless network.)
- Wireless LAN, by its nature, may cause interference, depending on the operating conditions (AP performance, distance, obstacles, interference by other radio devices, etc).
- Set the wireless IP sharer to Infrastructure mode. Ad-hoc mode is not supported.
- The player supports only the following wireless security key protocols : WEP (OPEN/SHARED), WPA-PSK (TKIP/AES), WPA2-PSK (TKIP/AES)
- Due to changes in WiFi policy, this player cannot support the TKIP encryption method in the 802.11n mode.
- To use the AllShare function, you must connect your PC to your network as shown in the figure. The connection can be wired or wireless.

Setup

Initial Settings

1. Turn on your TV after connecting the player. When you connect the player to a TV for the first time, player turns on automatically and the Initial Settings screen appears.

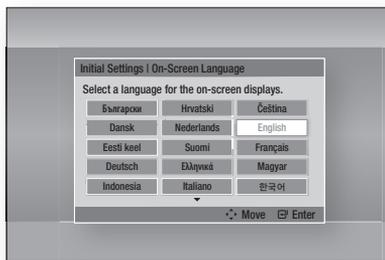

2. Press the **▲▼◀▶** buttons to select the desired language, and then press the **ENTER** button.
3. Press the **ENTER** button to select **Start**.
4. Press the **▲▼** buttons to select the desired TV Aspect Ratio, and then press the **ENTER** button. (See page 26)
5. Press the **▲▼** buttons to select the desired Network Settings : **Wired**, **Wireless (General)**, **WPS(PBC)** or **One Foot Connection**, and then press the **ENTER** button. If you do not know the details of your Network Settings, press the **BLUE (D)** button on your remote instead to skip Network Settings here, finish the Initial Settings, and go to the Home menu. If you selected a Network Setting, go to pages 31~35 for more information about the Network settings. When done, go to Step 6.
6. The Home menu appears. (For more information about the Home menu, please see page 25.)

• Home Menu

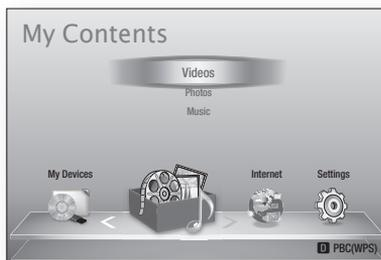

NOTE

- When the player is connected to the TV for the first time, the player turns on automatically. This is not malfunction.
- The Home menu will not appear if you do not configure the initial settings except as noted below.
- If you press the **BLUE (D)** button during the network setup, you can access the Home menu even if the network setup is not completed yet.
- If you want to display the Initial Setting screen again to make changes, select the Reset option. (See page 36)
- If you use an HDMI cable to connect the player to an **Anynet+(HDMI-CEC)**-compliant Samsung TV and 1.) You have set the **Anynet+(HDMI-CEC)** feature to **On** in both the TV and the player and 2.) You have set the TV to a language supported by the player, the player will select that language as the preferred language automatically.
- If you leave the player in the stop mode for more than 5 minutes without using it, a screen saver will appear on your TV. If the player is left in the screen saver mode for more than 20 minutes, the power will automatically turn off.

Accessing the Settings Menu

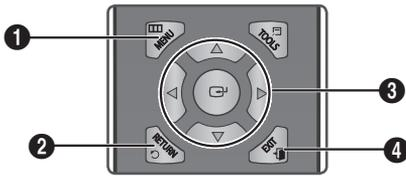

1 MENU Button : Press to move to the Home menu.

2 RETURN Button : Return to the previous menu.

3 ENTER / DIRECTION Button :
Move the cursor or select an item.
Activate the currently selected item.
Confirm a setting.

4 EXIT Button : Press to exit the current menu.

2. Press the ◀▶ buttons to select **Settings**, and then press the **ENTER** button.
3. Press the ▲▼ buttons to select the desired submenu, and then press the **ENTER** button.
4. Press the ▲▼ buttons to select the desired item, and then press the **ENTER** button.
5. Press the **EXIT** button to exit the menu.

NOTE

- When the player is connected to a network, select **Smart Hub** from the Home menu. Download the desired content from **Samsung Apps**. (See pages 56~58)
- The access steps may differ depending on the menu you selected.
- The OSD (On Screen Display) may change in this player after you upgrade the software version.

To access the Settings menu and sub-menus, follow these steps:

1. Press the **POWER** button.
The Home Menu appears.

• Home Menu

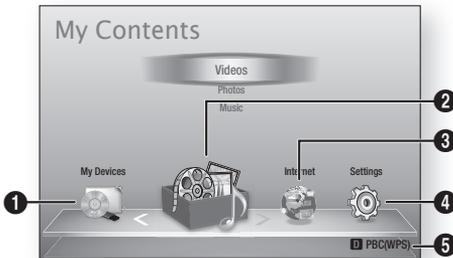

1 Selects My Devices.

2 Selects My Contents.

3 Selects Internet.

4 Selects Settings.

5 Displays the buttons available.

Setup

Display

You can configure various display options such as the TV Aspect Ratio, Resolution, etc.

TV Aspect

Depending on the type of television you have, you may want to adjust the screen size setting.

- **16:9 Original** : Select when you connect the player to a 16:9 TV screen. The player will display all content in its original aspect ratio. Content formatted in 4:3 will be displayed with black bars on the left and right.
- **16:9 Full** : Select when you connect the player to a 16:9 TV screen. All content will fill the full screen. Content formatted in 4:3 will be stretched.
- **4:3 Letter Box** : Select when you connect the player to a 4:3 TV screen. The player will display all content in its original aspect ratio. Content formatted in 16:9 will be displayed with black bars on the top and bottom.
- **4:3 Pan-Scan** : Select when you connect the player to a 4:3 TV screen. 16:9 content will have the extreme left and right portions cut off.



NOTE

- Depending on the disc type, some aspect ratios may not be available.
- If you select an aspect ratio and option which is different than the aspect ratio of your TV screen, then the picture might appear to be distorted.
- If you select the 16:9 Original, your TV may display 4:3 Pillarbox (black bars on sides of picture).

Smart Hub Screen Size

Set the Smart Hub Screen to the optimal size.

- **Size 1** : Smart Hub screen size will be smaller than default. You may see some black on sides of screen.
- **Size 2** : This is the default setting for Smart Hub. The player displays the normal Smart Hub screen size.
- **Size 3** : This will display a larger Smart Hub screen size. The image may be too large for your TV screen.

BD Wise (Samsung Players only)

BD Wise is Samsung's latest inter-connectivity feature.

When you connect a Samsung player and a Samsung TV with BD Wise to each other via HDMI, and BD Wise is on in both the player and TV, the player outputs video at the video resolution and frame rate of the Blu-ray Disc/DVDs.

- **Off** : The output resolution stays fixed at the resolution you set previously in the Resolution menu, regardless of the resolution of the disc. See Resolution below.
- **On** : The player outputs video at the original resolution and frame rate of the Blu-ray Disc/DVDs.



NOTE

- When BD Wise is on, the Resolution setting automatically defaults to BD Wise and BD Wise appears in the Resolution menu.
- If the player is connected to a device that does not support BD Wise, you can not use the BD Wise function.
- For proper operation of BD Wise, set the BD Wise menu of both the player and the TV to **On**.

Resolution

Lets you set the output resolution of the HDMI video signal to Auto, 1080p, 1080i, 720p, 480p or 480i. The number indicates the number of lines of video per frame. The i and p indicate interlaced and progressive scan, respectively. The more lines, the higher the quality.

- **Auto** : Automatically sets the output resolution to the connected TV's maximum resolution.
- **BD Wise** : Automatically sets the resolution to the resolution of the Blu-ray Disc/DVDs if you have connected the player via HDMI to a TV with the BD Wise feature. (The BD Wise menu item appears only if BD Wise is set to **On**. See BD Wise above.)
- **1080p** : Outputs 1080 lines of progressive video.
- **1080i** : Outputs 1080 lines of interlaced video.
- **720p** : Outputs 720 lines of progressive video.
- **480p** : Outputs 480 lines of progressive video.
- **480i** : Outputs 480 lines of interlaced video.

Resolution according to the output mode

• Blu-ray Disc/E-contents/Digital Contents playback

Setup	Output	HDMI / connected		HDMI / not connected
		HDMI Mode		VIDEO Mode
		Blu-ray Disc	E-contents/Digital contents	
BD Wise	Resolution of Blu-ray Disc	1080p@60F		-
Auto	Max. Resolution of TV input	Max. Resolution of TV input		-
1080p@60F	1080p@60F	1080p@60F		-
Movie Frame : Auto (24Fs)	1080p@24F	1080p@24F		-
1080i	1080i	1080i		480i
720p	720p	720p		480i
480p	480p	480p		480i
480i	-	-		480i

• DVD playback

Setup	Output	HDMI / connected	HDMI / not connected
		HDMI Mode	VIDEO Mode
BD Wise		480i	-
Auto		Max. Resolution of TV input	-
1080p@60F		1080p@60F	-
1080i		1080i	480i
720p		720p	480i
480p		480p	480i
480i		-	480i

NOTE

- If the TV you connected to the player does not support Movie Frame or the resolution you selected, the message "If no pictures are shown after selecting 'Yes', please wait for 15 seconds to return to the previous resolution. Do you want to change the resolution?" appears. If you select Yes, the TV's screen will go blank for 15 seconds, and then the resolution will revert to the previous resolution automatically.
- If the screen stays blank after you have changed the resolution, remove all discs, and then press and hold the **STOP** () button on the front of the player for more than 5 seconds. All settings are restored to the factory default. Follow the steps on the previous page to access each mode and select the Display Setup that your TV will support.
- When the factory default settings are restored, all stored user BD data is deleted.
- The Blu-ray Disc must have the 24 frame feature for the player to use the Movie Frame (24Fs) mode.

Setup

HDMI Color Format

Lets you set the color space format for HDMI output to match the capabilities of the connected device (TV, monitor, etc).

- **Auto** : Automatically sets the player to the optimum format supported by your device.
- **YCbCr (4:4:4)** : If your TV supports the YCbCr color space via HDMI, select this to output the normal YCbCr color gamut.
- **RGB (Standard)** : Select to output the normal RGB color gamut.
- **RGB (Enhanced)** : If you have connected the player to a DVI display device such as a monitor, select this to output the enhanced RGB color gamut.

Movie Frame (24Fs)

Setting the Movie Frame (24Fs) feature to **Auto** allows you to adjust the player's HDMI output to 24 frames per second for improved picture quality. You can enjoy the Movie Frame (24Fs) feature only on a TV supporting this frame rate. You can select Movie Frame only when the player is in the HDMI 1080i or 1080p output resolution modes.

- **Auto** : Movie Frame (24Fs) functions work.
- **Off** : Movie Frame (24Fs) functions are off.

HDMI Deep Color

Lets you output video from the HDMI OUT jack with Deep Color. Deep Color provides more accurate color reproduction with greater color depth.

- **Auto** : The player outputs video with Deep Color to a connected TV which supports HDMI Deep Color.
- **Off** : The picture is output without Deep Color.

Still Mode

Lets you set the type of picture the player displays when you pause DVD playback.

- **Auto** : Automatically shows the best still picture depending on the content.
- **Frame** : Select when pausing a scene with a little action.
- **Field** : Select when pausing a scene with a lot of action.

Progressive Mode

Lets you improve picture quality when viewing DVDs.

- **Auto** : Select to have the player automatically select the best picture quality for the DVD you're watching.
- **Video** : Select for the best picture quality from concert or TV show DVDs.

Audio

Digital Output

You set the Digital Output to match the capabilities of the AV receiver you've connected to the player :

- **PCM** : Choose if you have connected an HDMI supported AV receiver.
- **Bitstream (Unprocessed)** : Select if you have connected an HDMI supported AV receiver with Dolby TrueHD and DTS-HD Master Audio decoding capabilities.
- **Bitstream (Re-encoded DTS)** : Choose if you have connected an AV receiver using a Digital Optical input that can decode DTS.
- **Bitstream (Re-encoded Dolby D)** : Select if you don't have an HDMI supported AV receiver, but have a AV receiver with Dolby Digital decoding capabilities.

For more details, please refer to the digital output selection table. (See page 29)

Digital Output Selection

Setup		PCM		Bitstream (Unprocessed)		Bitstream (Re-encoded DTS)	Bitstream (Re-encoded Dolby D)
		HDMI supported AV receiver	Optical	HDMI supported AV receiver	Optical	HDMI supported AV receiver or Optical	HDMI supported AV receiver or Optical
Audio Stream on Blu-ray Disc	PCM	Up to 7.1ch	PCM 2ch	PCM	PCM 2ch	DTS re-encoded	Re-encoded Dolby Digital *
	Dolby Digital	PCM 2ch	PCM 2ch	Dolby Digital	Dolby Digital	DTS re-encoded	Re-encoded Dolby Digital *
	Dolby Digital Plus	PCM 2ch	PCM 2ch	Dolby Digital Plus	Dolby Digital	DTS re-encoded	Re-encoded Dolby Digital *
	Dolby TrueHD	PCM 2ch	PCM 2ch	Dolby TrueHD	Dolby Digital	DTS re-encoded	Re-encoded Dolby Digital *
	DTS	PCM 2ch	PCM 2ch	DTS	DTS	DTS re-encoded	Re-encoded Dolby Digital *
	DTS-HD HRA	PCM 2ch	PCM 2ch	DTS-HD HRA	DTS	DTS re-encoded	Re-encoded Dolby Digital *
	DTS-HD MA	PCM 2ch	PCM 2ch	DTS-HD MA	DTS	DTS re-encoded	Re-encoded Dolby Digital *
Audio Stream on DVD	PCM	PCM 2ch	PCM 2ch	PCM 2ch	PCM 2ch	PCM 2ch	PCM 2ch
	Dolby Digital	PCM 2ch	PCM 2ch	Dolby Digital	Dolby Digital	Dolby Digital	Dolby Digital
	DTS	PCM 2ch	PCM 2ch	DTS	DTS	DTS	DTS
Definition for Blu-ray Disc	Any	Decodes the main feature audio and BONUSVIEW audio stream together into PCM audio and adds Navigation Sound Effects.		Outputs only the main feature audio stream so that your AV receiver can decode the audio bitstream. You will not hear BONUSVIEW audio or Navigation Sound Effects.		Decodes the main feature audio and BONUSVIEW audio stream together into PCM audio and adds Navigation Sound Effects, then re-encodes the PCM audio into DTS bitstream.	Decodes the main feature audio and BONUSVIEW audio stream together into PCM audio and adds Navigation Sound Effects, then re-encodes the PCM audio into Dolby digital bitstream or PCM.

* If the Source Stream is 2ch, "Re-encoded Dolby D" Setting are not applied. Output will be LPCM 2ch.

Blu-ray Discs may include three audio streams :

- Main Feature Audio : The audio soundtrack of the main feature.
- BONUSVIEW audio : An additional soundtrack such as the director or actor's commentary.
- Navigation Sound Effects : When you choose some menu navigation, Navigation Sound Effects may sound. Navigation Sound Effects are different on each Blu-ray Disc.

Setup

NOTE

- Be sure to select the correct Digital Output or you will hear no sound or just loud noise.
- If the HDMI device (AV receiver, TV) is not compatible with compressed formats (Dolby digital, DTS), the audio signal outputs as PCM.
- Regular DVDs do not have BONUSVIEW audio and Navigation Sound Effects.
- Some Blu-ray Discs do not have BONUSVIEW audio and Navigation Sound Effects.
- This Digital Output setup does not effect the analog (L/R) audio or HDMI audio output to your TV. It effects the optical and HDMI audio output when your player is connected to a AV receiver.
- If you play MPEG audio soundtracks, the audio signal outputs as PCM regardless of your Digital Output selections (PCM or Bitstream).

PCM Downsampling

Lets you set 48kHz and 96kHz PCM down-sampling on or off.

- **Off** : Select when the AV receiver connected to the player is 96kHz compatible.
- **On** : Select when the AV receiver connected to the player is not 96kHz compatible. 96kHz signals will be down converted to 48kHz.

NOTE

- Even when PCM Downsampling is set to **Off**, some discs will only output downsampled audio through the optical digital outputs.

HDMI

- If your TV is not compatible with compressed multi-channel formats (Dolby Digital, DTS), the player may output PCM 2ch downmixed audio even though you selected Bitstream (either Re-encoded or Unprocessed) in the setup menu.
- If your TV is not compatible with PCM sampling rates over 48kHz, the player may output 48kHz downsampled PCM audio even though you set PCM Downsampling to **Off**.

Dynamic Range Control

You can listen at low volumes, but still hear dialog clearly.

This is only active if your player detects a Dolby Digital signal.

- **Auto** : The Dynamic Range Control will be set automatically based on the information provided by the Dolby TrueHD Soundtrack.
- **Off** : You can enjoy the movie with the standard Dynamic Range.
- **On** : When Movie soundtracks are played at low volume or through smaller speakers, the system can apply appropriate compression to make low-level content more intelligible and prevent dramatic passages from getting too loud.

Downmixing Mode

Lets you select how the player will downmix multi-channel audio into fewer channels.

- **Normal Stereo** : Downmixes the multi-channel audio into two channel stereo. Choose when connected to equipment that does not support virtual surround functions such as Dolby Pro Logic.
- **Surround Compatible** : Downmixes multi-channel audio into surround compatible stereo. Choose when connected to equipment that supports virtual surround functions such as Dolby Pro Logic.

Network

Before you begin, contact your ISP to find out if your IP address is static or dynamic. If it is dynamic, and you are using a wired or wireless connection, we recommend using the Auto procedures. If you are using a wireless connection and your router has the capability, you can use WPS(PBC) or One Foot Connection.

If your IP address is static, you must use the manual set up procedure for both wired and wireless connections.

Network Settings

To begin setting up the network connection for your player, follow these steps:

1. In the Home menu, press the ◀▶ buttons to select the **Settings**, and then press the **ENTER** button.
2. Press the ▲▼ buttons to select **Network**, and then press the **ENTER** button.
3. Press the ▲▼ buttons to select **Network Settings**, and then press the **ENTER** button.
4. Press the ▲▼ buttons to select **Wired**, **Wireless (General)**, **WPS(PBC)** or **One Foot Connection**, and then press the **ENTER** button.
5. If you have a wired network, go to **Wired Network** below. If you have a wireless network, go to **Wireless Network** on pages 32~34.

Wired Network

Setting Up a Wired Connection - Auto

1. Press the ▲▼ buttons to select **Wired**.

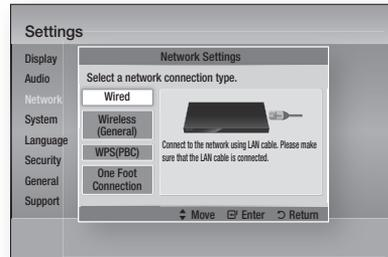

2. Press the **ENTER** button.
The Network Status screen appears. The player connects to the network after the network connection is verified.

Setting Up a Wired Connection - Manual

If you have a static IP address or the Auto Setting does not work, you'll need to set the Network Settings values manually.

To view your Network Settings values on most Windows computers, follow these steps:

■ Windows XP

1. Right click the Network icon on the bottom right of the Windows desktop.
2. In the pop-up menu, click Status.
3. On the dialog that appears, click the Support tab.
4. On the Support tab, click the Details button. The Network settings are displayed.

■ Windows 7

1. Click the Network icon on the bottom right of the Windows desktop.
2. In the pop-up menu, click Network and Sharing Center.

Setup

3. On the dialog that appears, click the Local Area Connection or Wireless Network Connection depending on your network connection.
4. On the Support tab, click the Details button. The Network settings are displayed.



NOTE

- Depending on your Windows version, the information may differ.

To enter the Network settings into your player, follow these steps:

1. Press the ▲▼ buttons to select **Wired**, and then press the **ENTER** button.
2. Press the ◀▶ buttons to select **IP Settings**, and then press the **ENTER** button.
3. On the Network Status screen, select Cancel, and then press Enter.

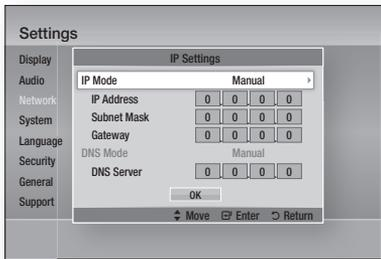

4. Press the **ENTER** button to select **IP Mode**.
5. Press the ▲▼ buttons to select **Manual**, and then press the **ENTER** button.
6. Press the ▼ button to go to the first entry field (IP Address).
7. Use the number buttons on your remote to enter numbers.
8. When done with each field, press the ▶ button to move successively to the next field. You can also use the other arrow buttons to move up, down, and back.
9. Enter the **IP Address**, **Subnet Mask**, and **Gateway** values.

10. Press the ▼ button to go to **DNS Mode**.
11. Press the ▼ button to go to the first DNS entry field. Enter the numbers as above.
12. Press the **ENTER** button to select **OK**. The Network Status screen appears. The player connects to the network after the network connection is verified.

Wireless Network

You can setup a wireless network three ways:

- Wireless (General)
- Using WPS(PBC)
- One Foot Connection

Wireless (General) includes both Automatic and Manual setup procedures.

Setting Up the Wireless Network Connection - Auto

Most wireless networks have an optional security system that requires devices that access the network to transmit an encrypted security code called an Access or Security Key. The Security Key is based on a Pass Phrase, typically a word or a series of letters and numbers of a specified length you were asked to enter when you set up security for your wireless network. If you use this method of setting up the network connection, and have a Security Key for your wireless network, you will have to enter the Pass Phrase during the Auto setup process.

1. Press the ▲▼ buttons to select **Wireless (General)**.

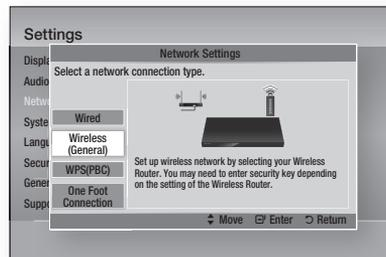

2. Press the **ENTER** button. When done, it displays a list of the available networks.

- Press the ▲▼ buttons to select the desired network, and then press the **ENTER** button. The Security screen appears.
- On the Security screen, enter your network's Pass Phrase. Enter numbers directly using your remote control.
To select a letter, press the ▲▼◀▶ buttons to move the cursor, then press the **ENTER** button.



NOTE

- You should be able to find the Pass Phrase on one of the set up screens you used to set up your router or modem.
- When done, press the **GREEN (B)** button on your remote or press the ▲▼◀▶ buttons to move the cursor to **Done**, and then press the **ENTER** button.
The Network Status screen appears. The player connects to the network after the network connection is verified.

Setting Up the Wireless Network Connection - Manual

If the Auto Setting does not work, you need to enter the Network setting values manually. To view the Network Settings values on most Windows computers, follow these steps:

■ Windows XP

- Right click the Network icon on the bottom right of the Windows desktop.
- In the pop-up menu, click Status.
- On the dialog that appears, click the Support tab.
- On the Support tab, click the Details button. The Network settings are displayed.

■ Windows 7

- Click the Network icon on the bottom right of the Windows desktop.
- In the pop-up menu, click Network and Sharing Center.
- On the dialog that appears, click the Local Area Connection or Wireless Network Connection depending on your network connection.
- On the Support tab, click the Details button. The Network settings are displayed.

NOTE

- Depending on your Windows version, the information may differ.

To enter the Network settings into your player, follow these steps:

- Follow Steps 1 through 4 in the 'Setting Up the Wireless Network Connection - Auto' procedure.
- When done, press the **GREEN (B)** button on your remote or press the ▲▼◀▶ buttons to move the cursor to **Done**, and then press the **ENTER** button. The Network Status screen appears.

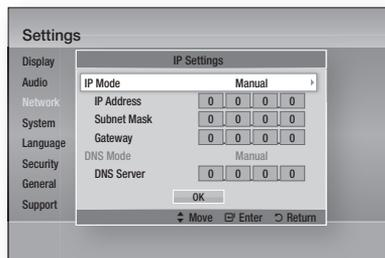

- On the Network Status screen, select Cancel, and then press Enter.
- Press the ◀▶ buttons to select **IP Settings**, and then press the **ENTER** button.
- Press the **ENTER** button to select **IP Mode**.
- Press the ▲▼ buttons to select **Manual**, and then press the **ENTER** button.
- Press the ▼ button to go to the first entry field (IP Address).

Setup

- Use the number buttons to enter numbers.
- When done with each field, press the ► button to move successively to the next field. You can also use the other arrow buttons to move up, down, and back.
- Enter the **IP Address**, **Subnet Mask**, and **Gateway** values.
- Press the ▼ to go to **DNS Mode**.
- Press the ▼ button to go to the first DNS entry field. Enter the numbers as above.
- Press the **OK** button.
- The Network Status screen appears. The player connects to the network after the network connection is verified.

WPS(PBC)

The easiest way to set up the wireless network connection is using the WPS(PBC) function or the One Foot Connection function.

If your wireless router has a **WPS(PBC)** button, follow these steps:

- Press the ▲▼ buttons to select **WPS(PBC)**.

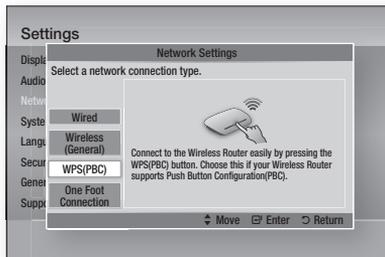

- Press the **ENTER** button.
- Press the **WPS(PBC)** button on your router within two minutes. Your player displays the Network Selection Screen, and automatically acquires all the network settings values it needs and connects to your network.
- The Network Status screen appears. The player connects to the network after the network connection is verified.

One Foot Connection

You can set up the wireless connection automatically if you have a Samsung Wireless Router which supports One Foot Connection. To connect using the One Foot Connection function, follow these steps:

- Press the ▲▼ buttons to select **One Foot Connection**.

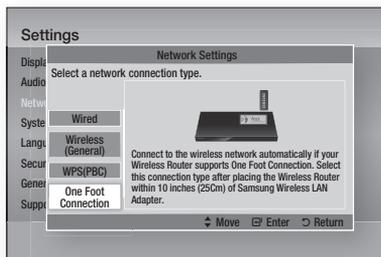

- Press the **ENTER** button.
- Place the Samsung Wireless Router within 25 cm (10 inches) of your player to connect.
- Wait until the connection is automatically established.

Network Status

Check whether a connection to the network and the Internet have been established.

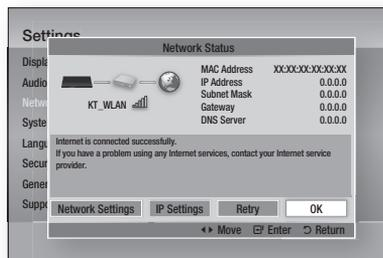

BD-LIVE Internet Connection

Set to allow or prohibit an Internet connection when you use the BD-LIVE service.

- **Allow (All)** : The Internet connection is allowed for all BD-LIVE contents.
- **Allow (Valid Only)** : The Internet connection is allowed only for BD-LIVE contents containing a valid certificate.
- **Prohibit** : No Internet connection is allowed for any BD-LIVE content.

NOTE

- **What is a valid certificate?**
When the player uses BD-LIVE to send the disc data and a request to the server to certify the disc, the server uses the transmitted data to check if the disc is valid and sends the certificate back to the player.
- The Internet connection may be restricted while you are using BD-LIVE contents.

System

Initial Settings

By using the Initial Settings function, you can set the language, Network Settings, etc. For more information about the Initial Settings function, refer to the Initial Settings section of this user manual.
(See pages 24~39)

Anynet+(HDMI-CEC)

Anynet+ is a convenient function that offers linked operations with other Samsung players that have the Anynet+ feature.

To operate this function, connect this player to a Samsung TV with an HDMI cable.

With Anynet+ on, you can operate this player using a Samsung TV remote control and start disc playback simply by pressing the **PLAY** () button on the TV's remote control.

For more information, please see the TV user manual.

- **Off** : Anynet+ functions will not work.
- **On** : Anynet+ functions will work.

NOTE

- This function is not available if the HDMI cable does not support CEC.
- If your Samsung TV has an Anynet+ logo, then it supports the Anynet+ function.
- Depending on your TV, certain HDMI output resolutions may not work.
Please refer to the user manual of your TV.

BD Data Management

Enables you to manage the downloaded contents you accessed through a Blu-ray disc that supports the BD-LIVE service and stored on a flash drive.

You can check the device's information including the storage size, delete the BD data, or change the Flash memory device.

BD Data Management Screen Information :

- **Total Size** : Total memory size of the device.
- **Available Size** : Available memory in the device.

NOTE

- In the external memory mode, disc playback may be stopped if you disconnect the USB device in the middle of playback.
- Only those USB devices formatted in FAT file system (DOS 8.3 volume label) are supported. We recommend you use USB devices that support USB 2.0 protocol with 4 MB/sec or faster read/write speed.
- The Resume Play function may not work after you format the storage device.
- The total memory available to BD Data Management may differ, depending on the conditions.

Setup

Time Zone

You can specify the time zone that is applicable to your area.

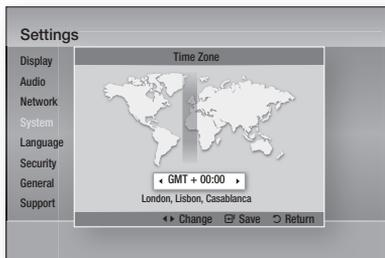

DivX® Video On Demand

View DivX® VOD Registration Codes to purchase and play DivX® VOD contents.

Reset

All settings will revert to the default except for the network and Smart Hub settings.

Language

You can select the language you prefer for the Home menu, disc menu, etc.

- **On-Screen Menu** : Select the language for the on-screen displays.
- **Disc Menu** : Select the language for the disc menu displays.
- **Audio** : Select the language for disc audio.
- **Subtitle** : Select the language for disc subtitles.

NOTE

- The selected language will only appear if it is supported on the disc.

Security

This function works in conjunction with Blu-ray Disc/DVDs that have been assigned an age rating or numeric rating that indicates the maturity level of the content. These numbers help you control the types of Blu-ray Disc/DVDs that your family can watch.

Select an age rating you want to set for the BD Parental Rating and a rating level you want to set for the DVD Parental Rating. The player will only play Blu-ray Discs rated at or below the age rating and DVDs rated below the numeric rating unless the password is entered.

Larger numbers indicate more mature content.

BD Parental Rating

Prevent playback of Blu-ray Discs with specific age ratings unless a password is entered.

DVD Parental Rating

Prevent playback of DVDs with specific numerical ratings unless a password is entered.

Change Password

Change the 4-digit password used to access security functions.

If you forgot your password

1. Remove the disc.
2. Press and hold the **STOP** (■) button on the front panel for 5 seconds or more.
All settings will revert to the factory settings.

NOTE

- When the factory default settings are restored, all the user stored BD data will be deleted.

Front Display

Change the brightness of the front panel.

- **Auto** : Dim during playback.
- **Dim** : Dim the display window.
- **Bright** : Brighten the display window.

Network Remote Control

The Network Remote Control function lets you control your Blu-ray Disc player from a remote device such as a smart phone through a wireless connection to your local area network.

To use the Network Remote Control function, follow these steps:

1. Select **On** in the Network Remote Control menu.
2. Install the Samsung network remote control application to control your player on your compatible portable device.
3. Make sure your portable device and your player are connected to the same wireless router.
4. Start the application on your portable device. The application should find your player and display it on a list.
5. Select the player.
6. If this is the first time you are using the function, it will ask you to allow or deny remote control of the player. Select **Allow**.
7. Follow the instructions that came with the application to control the player.

Software Upgrade

The Software Upgrade menu allows you to upgrade the player's software for performance improvements or additional services. You can upgrade in four ways:

- By Internet
- By USB
- By Disc
- By Downloaded (File)

The four methods are explained below.

By Internet

To upgrade by Internet, follow these steps:

1. Select **By Internet**, and then press the **ENTER** button. The Connecting to Server message appears.
2. If there is a download available, the Download pop-up appears with a progress bar and the download starts.
3. When the download is complete, the Upgrade Query window appears with three choices: Upgrade Now, Upgrade Later, or Don't Upgrade.
4. If you select Upgrade Now, the player upgrades the software, turns off, and then turns on automatically.
5. If you do not make a selection in one minute or select Upgrade Later, the player stores the new upgrade software. You can upgrade the software later using the By Downloaded function.
6. If you select Don't Upgrade, the player cancels the upgrade.

NOTE

- Your player must be connected to the Internet to use the By Internet function.
- The upgrade is complete when the player turns off, and then turns on again by itself.
- Never turn the player off or back on manually during the update process.

Setup

- Samsung Electronics shall take no legal responsibility for player malfunction caused by an unstable Internet connection or consumer negligence during a software upgrade.
- If you want to cancel the upgrade while the upgrade software is downloading, press the **ENTER** button.

By USB

To upgrade by USB, follow these steps:

1. Visit www.samsung.com/bluraysupport
2. Download the latest USB software upgrade zip archive to your computer.
3. Unzip the zip archive to your computer. You should have a single folder with the same name as the zip file.
4. Copy the folder to a USB flash drive.
5. Make sure the disc tray is empty, and then insert the USB flash drive into the USB port of the player.
6. In the player's menu, go to Settings > Support > Software Upgrade.
7. Select **By USB**.

NOTE

- The disc tray must be empty when you upgrade the software using the USB Host jack.
- When the software upgrade is done, check the software details in the software Upgrade menu.
- Do not turn off the player during the software upgrade. It may cause the player to malfunction.
- Software upgrades using the USB Host jack must be performed with a USB memory flash stick only.

By Disc

To upgrade by Disc, follow these steps:

1. Visit www.samsung.com/bluraysupport.
2. Download the latest disc software upgrade zip archive to your computer.
3. Unzip the zip archive to your computer. You should have a single folder with the same name as the zip file.
4. Write the folder onto a disc. We recommend a CD-R or DVD-R.

5. Finalize the disc before you remove it from your computer.
6. Insert the disc into player.
7. In the player's menu, go to Settings > Support > Software upgrade.
8. Select **By Disc**.

NOTE

- When the system upgrade is done, check the software details in the software Upgrade menu.
- Do not turn off the player during the Software Upgrade. It may cause the player to malfunction.

By Downloaded

The By Downloaded option lets you upgrade using a file the player downloaded earlier but you decided not to install immediately or a file downloaded by the player in Standby Mode (See Download in Standby Mode below).

To upgrade By Downloaded, follow these steps:

1. If upgrade software has been downloaded, you will see the software version number to the right of By Downloaded.
2. Select By Downloaded, and then press the **ENTER** button.
3. The player displays a message asking if you want to upgrade. Select **Yes**. The player begins the upgrade.
4. When the update is complete, the player turns off automatically, and then turns on.

NOTE

- When the system upgrade is done, check the software details in the software Upgrade menu.
- Do not turn off the player during the software Upgrade. It may cause the player to malfunction.

Download in Standby Mode

You can set the Download in Standby Mode function so that the player downloads new upgrade software when it is in Standby mode. In Standby mode, the player is off, but its Internet connection is active. This allows the player to download upgrade software automatically, when you are not using it.

To set Download in Standby Mode, follow these steps:

1. Press the ▲▼ buttons to select **Download in Standby Mode**, and then press the **ENTER** button.
2. Select **On** or **Off**.
 - **Off** : If you select **Off**, the player will notify you with a pop up message when new upgrade software is available.
 - **On** : If you select **On**, the player will automatically download new upgrade software when it is in Standby mode with the power off. If it downloads new upgrade software, the player will ask you if you want to install it when you turn the player on.



NOTE

- To use the Downloaded in Standby Mode function, your player must be connected to the Internet.

Contact Samsung

Provides contact information for assistance with your player.

Basic Functions

Playing a Video

Playback

1. Press the **OPEN/CLOSE** () button to open the disc tray.
2. Place a disc gently into the tray with the disc's label facing up.

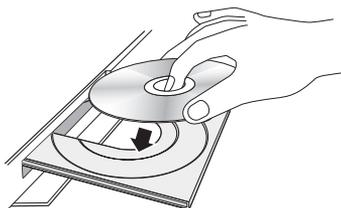

3. Press the **OPEN/CLOSE** () button to close the disc tray.
4. Press the **PLAY** () button.

Playback related buttons

PLAY ()	Starts playback.
STOP ()	Stops playback. <ul style="list-style-type: none"> • If you press the button once : The stop position is memorized. • If you press the button twice : The stop position is not memorized.
PAUSE ()	Pauses playback.

NOTE

- For some discs, pressing the **STOP** () button once may not memorize the stop position.
- Video files with high bit rates of 20Mbps or more strain the player's capabilities and may stop playing during playback.

Disc Structure

The content of discs are usually divided as shown below.

• Blu-ray Disc, DVD-VIDEO

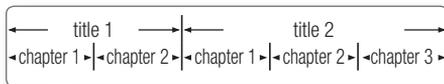

• Audio CD (CD-DA)



• MP3, WMA, DivX, MKV and MP4

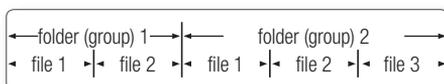

Using the Disc Menu/Title Menu/ Pop up Menu

Using the Disc Menu



1. During playback, press the **DISC MENU** button on the remote control.
2. Press the **▲▼◀▶** buttons to make a selection, and then press the **ENTER** button.



NOTE

- Depending on the disc, the menu items may differ and this menu may not be available.

Using the Title Menu

1. During playback, press the **TITLE MENU** button on the remote control.
2. Press the **▲▼◀▶** buttons to make the desired selection, then press the **ENTER** button.



TITLE MENU



NOTE

- Depending on the disc, the menu items may differ and this menu may not be available.

Playing the Title List

1. During playback, press the **DISC MENU** or **TITLE MENU** button.
2. Press the **▲▼** buttons to select an entry you want to play from the Title List, and then press the **ENTER** button.



DISC MENU



TITLE MENU



NOTE

- If your disc has a playlist, press the **GREEN (B)** button to go to the playlist.

Using the Popup Menu

1. During playback, press the **POPUP MENU** button on the remote control.
2. Press the **▲▼◀▶** buttons or **ENTER** button to select the desired menu.



TITLE MENU



NOTE

- Depending on the disc, the menu items may differ and this menu may not be available.

Using the Search and Skip Functions

During play, you can search quickly through a chapter or track, and use the skip function to jump to the next selection.

Searching for a Desired Scene



- During playback, press the **SEARCH** (**◀▶**) button.

Each time you press the **SEARCH** (**◀▶**) button, the playback speed will change as follows:

button, the playback speed will change as follows:

BD-ROM, BD-RE/-R, DVD-RW/-R, DVD+RW/+R, DVD-VIDEO	▶▶ 1 → ▶▶ 2 → ▶▶ 3 →
	▶▶ 4 → ▶▶ 5 → ▶▶ 6 → ▶▶ 7
	◀◀ 1 → ◀◀ 2 → ◀◀ 3 →
	◀◀ 4 → ◀◀ 5 → ◀◀ 6 → ◀◀ 7
DivX, MKV, MP4	▶▶ 1 → ▶▶ 2 → ▶▶ 3
	◀◀ 1 → ◀◀ 2 → ◀◀ 3

- To return to normal speed playback, press the **PLAY** (**▶**) button.

NOTE

- The player does not play sound in search mode.

Skipping Chapters



- During playback, press the **SKIP** (**▶▶**) button.

If you press the **SKIP** (**▶▶**) button, the disc moves to the next chapter.

If you press the **SKIP** (**◀◀**) button, the disc moves to the beginning of the chapter. One more press makes the disc move to the beginning of the previous chapter.

Basic Functions

Slow Motion Play/Step Motion Play

Slow Motion Play



- In pause mode, press the **SEARCH** () button.
Each time you press the **SEARCH** () button, the playback speed will change as follows:
▶▶ 1/8 ▶▶ 1/4 ▶▶ 1/2
- To return to normal speed playback, press the **PLAY** () button.

NOTE

- The player does not play sound in Slow mode.

Step Motion Play



- In pause mode, press the **PAUSE** () button.
Each time you press the **PAUSE** () button, a new frame appears.
- To return to normal speed playback, press the **PLAY** () button.

NOTE

- The player does not play sound in slow mode.

Using the TOOLS button

During playback, you can operate the disc menu by pressing the **TOOLS** button.



• Tools Menu Screen

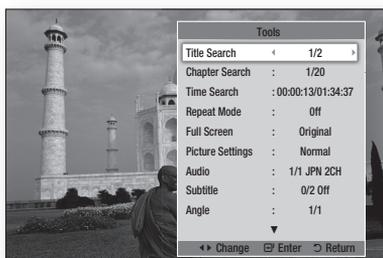

NOTE

- Depending on the disc, the Tools menu may differ.

Moving to a Desired Scene Directly



1. During playback, press the **TOOLS** button.
2. Press the **▲▼** buttons to select **Title Search**, **Chapter Search**, or **Time Search**.
3. Press the **◀▶** or number button to select desired Title, Chapter or Time, then press the **ENTER** button.

Repeating the Title or Chapter



To repeat the disc title or chapter.

Depending on the disc, the Repeat function may not be available.

1. During playback, press the **TOOLS** button.
2. Press the **▲▼** buttons to select **Repeat Mode**.
3. Press the **◀▶** buttons to select **Chapter** or **Title**, then press the **ENTER** button.
4. To return to normal play, press the **TOOLS** button again.
5. Press the **▲▼** buttons to select **Repeat Mode**.
6. Press the **◀▶** buttons to select **Off**, then press the **ENTER** button.

Repeating a Section



1. During playback, press the **TOOLS** button.
2. Press the **▲▼** buttons to select **Repeat Mode**.
3. Press the **◀▶** buttons to select **Repeat A-B**, then press the **ENTER** button.
4. Press the **ENTER** button at the point where you want repeat play to start (A).
5. Press the **ENTER** button at the point where you want repeat play to stop (B).
6. To return to normal play, press the **TOOLS** button again.
7. Press the **▲▼** buttons to select **Repeat Mode**.
8. Press the **◀▶** buttons to select **Off**, and then press the **ENTER** button.



NOTE

- If you set point (B) before 5 seconds has lapsed, a prohibition message appears.
- Depending on the disc, the menu items may differ and this menu may not be available.

Changing to Full Screen

1. During playback, press the **TOOLS** button.
2. Press the **▲▼** buttons to select **Full Screen**.
3. Press the **◀▶** buttons to select the desired mode.

NOTE

- This function is available when the TV aspect ratio is 16:9 full. (See page 26)

Selecting the Picture Settings



This function enables you to adjust video quality when the player is connected to a TV.

1. During playback, press the **TOOLS** button.
2. Press the **▲▼** buttons to select **Picture Settings**, and then press the **ENTER** button.
3. Press the **◀▶** buttons to select the desired **Picture Settings**.
 - **Dynamic** : Choose this setting to increase Sharpness.
 - **Normal** : Choose this setting for most viewing applications.
 - **Movie** : This is the best setting for watching movies.
 - **User** : Lets you adjust the sharpness and noise reduction function respectively.

NOTE

- When you use BD wise function, this menu will not appear.

Selecting the Audio Language



You can also operate this function by pressing the **AUDIO** button on the remote control.



1. During playback, press the **TOOLS** button.
2. Press the **▲▼** buttons to select **Audio**.
3. Press the **◀▶** buttons to select the desired audio language.

NOTE

- The **◀▶** indicator will not appear on the screen if the BONUSVIEW section does not contain any BONUSVIEW audio settings.
- Information about the main feature/BONUSVIEW mode will also appear if the Blu-ray Disc has a BONUSVIEW section.
Press the **◀▶** button to switch between main feature and BONUSVIEW audio modes.

Basic Functions

- This function depends on the selection of audio languages encoded on the disc and may not be available.
- A Blu-ray Disc can contain up to 32 audio languages and a DVD up to 8.
- Some Blu-ray Discs may allow you to select either the multi-channel LPCM or Dolby digital audio soundtrack in English.
- If you press the **AUDIO** button on the remote control, the Audio bar appears. Press the **RETURN** button to remove the Audio bar.

Selecting the Subtitle Language



You can also operate this function by pressing the **SUBTITLE** button on the remote control.



1. During playback, press the **TOOLS** button.
2. Press the **▲▼** buttons to select **Subtitle**.
3. Press the **◀▶** buttons to select the desired subtitle language.

NOTE

- Depending on the Blu-ray Disc / DVD, you may be able to change the desired subtitle in the Disc Menu. Press the **DISC MENU** button.
- This function depends on the selection of subtitles that are encoded on the disc and may not be available on all Blu-ray Discs/DVDs.
- A Blu-ray Disc can contain up to 255 subtitle languages and a DVD up to 32.
- Information about the main feature/BONUSVIEW mode will also appear if the Blu-ray Disc has a BONUSVIEW section.
- This function changes both the primary and secondary subtitles at the same time.
- The total numbers of primary and secondary subtitles are displayed respectively.
- If you press the **SUBTITLE** button on the remote control, the subtitle bar appears. Press the **RETURN** button to remove the subtitle bar.

Changing the Camera Angle



When a Blu-ray Disc/DVD contains multiple angles of a particular scene, you can use the **ANGLE** function.

1. During playback, press the **TOOLS** button.
2. Press the **▲▼** buttons to select **Angle**.
3. Press the **◀▶** buttons to select the desired Angle.

Setting BONUSVIEW



The **BONUSVIEW** feature allows you to view additional content (such as commentaries) in a small screen window while the movie is playing. This function is only available if the disc has the Bonusview feature.

1. During playback, press the **TOOLS** button.

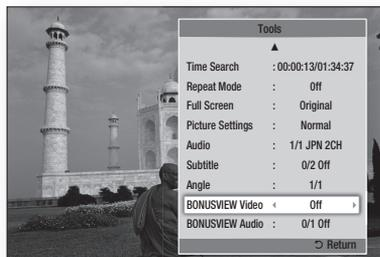

2. Press the **▲▼** buttons to select **BONUSVIEW Video** or **BONUSVIEW Audio**.
3. Press the **◀▶** buttons to select the desired Bonusview.

NOTE

- If you switch from **BONUSVIEW Video**, **BONUSVIEW Audio** will change automatically in accordance with **BONUSVIEW Video**.

Listening to Music



Buttons on the Remote Control used for Music Playback

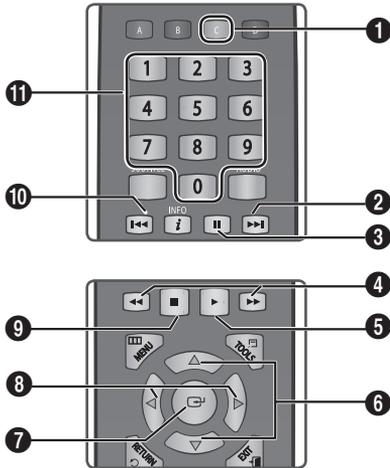

1	YELLOW (C) button : Displays check box in the music list.
2	SKIP button : During playback, moves to the next page in the Music List or moves to the next track in the Playlist.
3	PAUSE button : Pauses playback.
4	SEARCH buttons : Fast Play. (Audio CD (CD-DA) only)
5	PLAY button : Plays the currently selected track.
6	▲▼ buttons : Select a track in the Music List or Playlist.
7	ENTER button : Plays the selected track.
8	◀▶ buttons : Jump Play. (except for Audio CD (CD-DA))
9	STOP button : Stops a track.

SKIP button : During playback, moves to the previous page in the Music List or moves to the previous track in the Playlist.

- 10 If you press this button after three seconds of playback in the Playlist, the current track is replayed from the beginning. But, if you press this button less than three seconds after playback starts in the Playlist, the previous track is played.

- 11 **NUMBER buttons** : During the Playlist playback, press the desired track number. The selected track is played.

Playing an Audio CD (CD-DA)/MP3

1. Insert an Audio CD (CD-DA) or an MP3 Disc into the disc tray.
 - For an Audio CD (CD-DA), the first track plays automatically.
 - For an MP3 disc, press the ▲▼ buttons to select **Music**, then press the **ENTER** button.

Audio CD (CD-DA)/MP3 Screen Elements

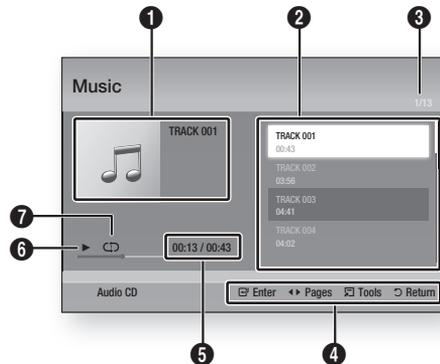

- | | |
|---|---|
| 1 | Displays the music information. |
| 2 | Displays the playlist. |
| 3 | Display the current track/total tracks. |
| 4 | Displays buttons available. |

Basic Functions

5	Shows the current play time/total play time.
6	Displays the current playback status.
7	Displays the repeated playback status.

- Press the ▲▼ buttons to select the track you want to play, and then press the **ENTER** button.

Repeat an Audio CD (CD-DA)/MP3

- During the Playlist playback, press the **TOOLS** button. 
- Press the ▲▼ buttons to select **Repeat Mode**, and then press the ◀▶ buttons to select the desired repeat mode.
- Press the ▲▼ buttons to select **Shuffle Mode**, and then press the ◀▶ buttons to select **On** or **Off**.
- Press the **ENTER** button.

Off	Songs are played in the order in which they were recorded.
(↺) One Song	The current song is repeated.
(↺) All	All songs are repeated.
(↻) Shuffle	The random option plays songs in random order. To operate this function, please set the shuffle mode to On .

Playlist

- Insert an Audio CD (CD-DA) or an MP3 Disc into the disc tray.
 - For an Audio CD (CD-DA), the first track plays automatically.
 - For an MP3 disc, press the ▲▼ buttons to select **Music**, then press the **ENTER** button.
- To move to the Music List, press the **STOP** (■) or **RETURN** button. The Music List screen appears.
- Press the **YELLOW (C)** button.

- Press the ▲▼◀▶ buttons to move to a desired track, and then press the **ENTER** button. A check appears on the track. Repeat this procedure to select additional tracks.



- To remove a track from the list, move to the track, and then press the **ENTER** button again. The check on the track is cancelled.
- When done, press the **TOOLS** button.
- Press the ▲▼ buttons to select **Play Selected**, and then press the **ENTER** button. The tracks you selected play automatically.

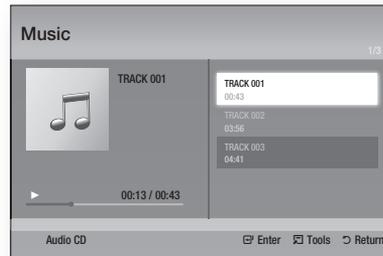

- To go to the Music List, press the **RETURN** button.

NOTE

- You can create a playlist with up to 99 tracks on Audio CDs (CD-DA).

Playing back Pictures



Playing a JPEG files

1. Insert a JPEG disc into the disc tray.
2. Press the ▲▼ buttons to select **Photos**, and then press the **ENTER** button.
3. Press the ▲▼◀▶ buttons to select the folder you want to play, and then press the **ENTER** button.
4. Press the ▲▼◀▶ buttons to select the photo you want to play, and then press the **ENTER** button.

NOTE

- You can't enlarge the subtitle and PG graphic in the full screen mode.

Using the TOOLS button

You can use various function by pressing the **TOOLS** button.

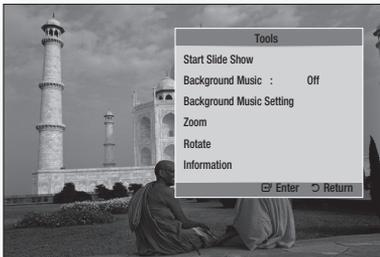

- **Start Slide Show** : Select to start the slide show.
- **Background Music** : Select to listen to music while viewing a picture.
- **Background Music Setting** : Select to set the background music setting.
- **Zoom** : Select to enlarge the current picture. (Enlarged up to 4 times)

- **Rotate** : Select to rotate the picture. (This will rotate the picture either clockwise or counter clockwise.)
- **Information** : Shows the picture information including the name and size, etc.

NOTE

- To enable the background music function, the photo file must be in the same storage media as the music file. However, the sound quality can be affected by the bit rate of the MP3 file, the size of the photo, and the encoding method.

Using the Slide Show function

1. Press the **TOOLS** button.
2. Press the ▲▼ buttons to select **Start Slide Show**, and then press the **ENTER** button. The Slide Show starts.
3. To pause the slide show, press the **TOOLS** button again.

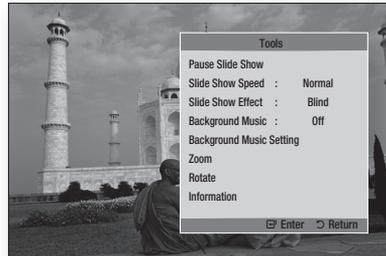

4. Press the ▲▼ buttons to select **Pause Slide Show**, and then press the **ENTER** button.
5. You can also set the slide show speed and effect using the same method.

Basic Functions

Playing back a USB Storage Device

You can use the USB connection to play multimedia files (MP3, JPEG, DivX, etc) located from a USB storage device.

1. Move to the Home menu.

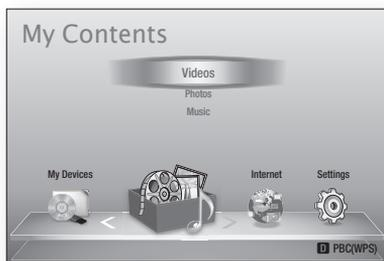

2. In Stop mode, connect the USB storage device to the USB port on the front panel of the player.



3. Press the **ENTER** button.
4. Press the **▲▼◀▶** buttons to select the desired Videos, Music, or Photos, and then press the **ENTER** button.
5. For playing back Video, Music or Photo files, see pages 40~47.

NOTE

- You must remove the USB storage device safely (by performing the "Safely Remove USB" function) in order to prevent a possible damage to the USB memory. Press the **MENU** button to move to the Home menu, select the **YELLOW (C)** button, and then press the **ENTER** button.
- If you insert a disc when playing a USB storage device, the device mode changes to "DVD or CD" automatically.

Network Services

You can enjoy various network services such as Smart Hub or BD-LIVE by connecting the player to your network.

Read the following instructions before using any network service.

1. Connect the player to the network.
(See pages 22~23)
2. Configure the network settings.
(See pages 31~35)

Using Smart Hub

Using Smart Hub, you can stream movies, videos, and music from the Internet, access various for pay or free-of-charge applications and view them on your TV. Application content includes news, sports, weather forecasts, stock market quotes, maps, photos, and games.

You can also start this function by pressing the **SMART HUB** button on the remote control.



Starting Smart Hub for the First Time

To start Smart Hub for the first time, follow these steps :

1. Go to the Home menu.

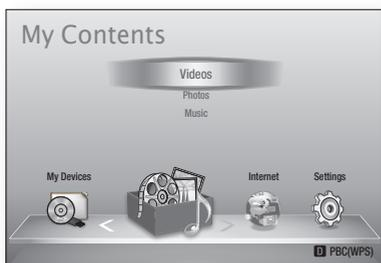

2. Press the ◀▶ buttons to select **Internet**, and then press the **ENTER** button.

3. The Smart Hub screen appears.
In a few cases, the Country screen appears immediately after.
4. If the Country screen has appeared, press the ▲▼ buttons to select your country, then press the **ENTER** button.

NOTE

- Certain applications are available only in certain countries.

5. The Terms of Service Agreement screen appears.
If you want to agree, press the ◀▶ buttons to select **Agree**, then press the **ENTER** button.

NOTE

- Screens can take a few seconds to appear.

6. The Service Update screen appears and installs a number of services and applications. When done, it closes. The applications and services downloaded are displayed on the Smart Hub screen. This may take some time.

NOTE

- Smart Hub may close momentarily during the installation process.
- A number of screens may appear after installation. You can press the **ENTER** button to close them or let them close on their own.

7. To start an application, press the ▲▼◀▶ buttons to highlight a widget, then press the **ENTER** button.

Network Services

Smart Hub at a Glance

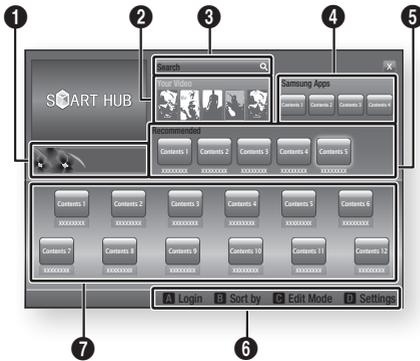

Navigation Help : Displays the remote control buttons you can use to navigate in Smart Hub.

- 6
 - **RED (A)** : To log in to Smart Hub.
 - **GREEN (B)** : To sort the applications.
 - **YELLOW (C)** : To edit the applications.
 - **BLUE (D)** : To change the settings of Smart Hub.

My Applications : Displays your personal gallery of applications which you can add to, modify, and delete.

NOTE

- Samsung Electronics takes no legal responsibility for any interruption of the Smart Hub service caused by the service provider for any reason.
- The Smart Hub service downloads and processes data via the Internet so that you can enjoy the Internet contents on your TV screen. If the Internet connection is unstable, the service may be delayed or interrupted. Furthermore, the player may turn off automatically in response to conditions on the Internet. If this occurs, check the Internet connection and try again.
- Application services may be provided in English only and the contents available may vary, depending on your area.
- For more information about a Smart Hub service, visit the web site of the applicable service provider.
- The services provided are subject to change by the Smart Hub service provider without notice.
- The Smart Hub service contents may differ depending on the player's firmware version.

1 Commercial : Displays the Smart Hub Guide, an introduction to the player, and new application introductions.

Your Video : Provides recommendations for videos based on your tastes.

- Lets you see movie recommendations based on your previous preferences.
- Lets you select a movie, displays a list of VOD (Video on Demand) providers that have the movie, and then lets you choose a provider for streaming. (Streaming is unavailable in some areas.)
- For instructions to use Your Video, please visit www.samsung.com.

Search : Provides an integrated search of your video providers and connected AllShare devices.

- Usable while using Smart Hub (except when you are watching a Blu-ray Disc).
- For easy access, use the **SEARCH** button on the remote control.
- For instructions to use search function, please visit www.samsung.com.

Samsung Apps : You can download various for pay or free-of-charge application services.

Recommended : Displays recommended contents managed by Samsung.

Using the Keypad

Through your remote, you can use the On-Screen Keypad to enter letters, numbers, and symbols.

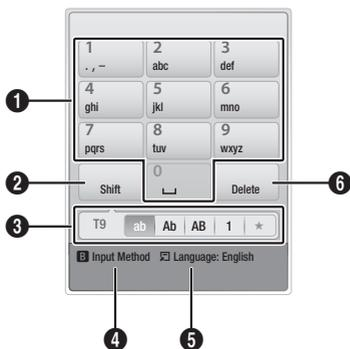

- 1 The current keypad. Use to enter letters, numbers, and symbols.
- 2 Press the **SUBTITLE** button on the remote control to shift the input mode. : ab, Ab, AB, numbers or icons.
- 3 Displays the current input mode.
- 4 Press the **GREEN (B)** button on the remote control to change the input method. (T9 or ABC)
- 5 Press the **TOOLS** button on the remote control to change the language.
- 6 Press the **AUDIO** button on the remote control to delete a character.

Entering Text, Numbers and Symbols

To enter text, press the number button on the remote that corresponds to the letter you want to enter. Press the button rapidly to enter a letter that is not the first letter listed on the On-Screen keypad button. For example, if you want to enter the letter b, press the 2 button on your remote rapidly twice. To enter the first letter listed on a button, press, release, and then wait.

To move within the text, use the Arrow buttons. To delete text, move the cursor to the right of the character you want to delete, and then press the **AUDIO** button. To change case or enter numbers or punctuation, press the **SUBTITLE** button.

Creating an Account

To establish your own, exclusive, configuration of Smart Hub, create your own Smart TV Account. To create an account, follow these steps:

1. Press the **RED (A)** button on your remote control. The Create Account screen appears.



2. Press the **▲▼▶◀** buttons to select **Create Account**, and then press the **ENTER** button.
3. On the next screen, select **Smart TV ID**, and then press the **ENTER** button. An entry screen and keypad appear.
4. Use the keypad to enter your e-mail address. This will serve as your ID.

NOTE

- The keypad works like the keypad on a cell phone.
5. When done, press the **ENTER** button to select **OK**, and then press the **ENTER** button again. The Create Account screen re-appears.
 6. Select **Password**, and then press the **ENTER** button. An entry screen and a keypad appear.
 7. Use the keypad to enter a password. The password can be any combination of letters, numbers, and symbols.

NOTE

- Press the **RED (A)** button on your remote to show or hide the password as you enter it.

Network Services

- When done, press the **ENTER** button to select **OK**, and then press the **ENTER** button again. The Create Account screen re-appears.
- Select **Confirm password**, and then press the **ENTER** button.
- Repeat Steps 7 and 8.
- When the Create Account screen re-appears, select **Create Account**, and then press the **ENTER** button. The Confirmation window appears.
- Select **OK**, and then press the **ENTER** button. The Continue to Register Service window appears.
- Select **Go Register**, and then press the **ENTER** button.
- The Register Service Account Window appears.
 - If you have existing accounts with any of the listed providers, you can associate the provider account and the provider account password with your Smart TV Account. Registration makes it easier to access the providers web site. For registration instructions, go to Step 2 in Account Management under the Settings Menu.
 - If you don't have existing provider accounts or do not want to register existing accounts at this time, select **OK**, and then press the **ENTER** button. You can also let the window close on its own in about a minute.

NOTE

- You must use an e-mail address as an ID.
- You can register up to 10 User Accounts.
- You do not need an account to use Smart Hub.

Account Log In

To log in to your Smart TV Account, follow these steps:

- With the Smart Hub main screen displayed on your TV, press the **RED (A)** button on your remote. The Create Account screen appears.
- Select the **Down Arrow** next to the **Smart TV ID** field, and then press the **ENTER** button.

- Select your ID from the list that appears, and then press the **ENTER** button. The Create Account screen re-appears.
- Select **Password**, and then press the **ENTER** button. An entry window and a keypad appears.
- Using the keypad and your remote, enter your password. When done, press the **ENTER** button, select **OK**, and then press the **ENTER** button again.

NOTE

- If you want Smart Hub to enter your password automatically, select Remember my Smart TV ID and password after you have entered your password, and then press the **ENTER** button. A check appears. Smart Hub will now enter your password automatically when you select or enter your ID.

The Settings Menu - BLUE (D)

The Settings Menu Screen gives you access to account management, reset, and properties functions.

To access the Settings Menu, and then select a menu item, follow these steps:

- Press the **BLUE (D)** button on your remote.
- Press the **▲▼** to select a menu item, and then press the **ENTER** button.

The functions on the Settings Menu screen are described below.

NOTE

- The Service Manager item listed in the Settings Menu is not available for Blu-ray Disc players.

Account Management

The Account Management Menu contains functions that let you register your service provider accounts, change your Smart Hub password, and delete or deactivate your Smart TV Account.

Register Service Account

If you have existing accounts with any of the providers listed by the Register Service Account function, you can associate the provider account and the provider account password with your Smart TV Account. If you associate the account, you will be able to log onto the account through Smart Hub easily, without entering your account name or password.

To use the Register Service Account function, follow these steps:

1. In the Account Management menu, select Register Service Account, and then press the **ENTER** button. The Register Service Account Window appears.
2. Press the **▲▼** arrow buttons to select a Service Provider you want to associate with your Smart TV Account, and then press the **ENTER** button.

NOTE

- If you have a Samsung apps account and you want to use the Samsung Apps function in Smart Hub, you must register your Samsung Apps account here. See page 56–58 for more information.
3. Press the **▲▼** buttons to select Register, and then using your remote and the on-screen Keypad, enter your site ID and password. When done, press the **ENTER** button.

NOTE

- This is the ID and password you normally use to access your account on this site.
4. If you have entered the ID and password correctly, the Registered Successfully message appears.
 5. If you pressed **OK**, repeat Steps 2 through 4 to associate another Service Provider.
 6. When you are done, press the **RETURN** button.

Change Password

The Change Password function lets you change your Smart Hub password. To change the password, follow these steps:

1. Select **Change Password**, and then press the **ENTER** button.
2. Enter your current password. The next screen appears.
3. On the next screen, enter a new password on the first line. Enter it again on the second line to confirm.
4. The Changing Password Complete message screen appears. Press the **ENTER** button or wait for the screen to close - about 5 seconds.

Remove Service Accounts

The Remove Service Accounts function cancels all your current registered Service Accounts that you registered on the Register Service Account screen.

Deactivate Account

The Deactivate Account function deactivates your Smart TV Account and deletes it and all your account settings entirely from Smart Hub.

Reset

The Reset function initializes all downloaded widgets, erases all user accounts and settings from the player, and resets all Smart Hub settings to the factory default settings. It then restarts Smart Hub as if it were starting for the first time. Your account, however, remains on the Smart Hub server. To log into your account, enter your ID and password on the Create Account screen.

To use the Reset function, follow these steps:

1. In the Settings menu, select Reset, and then press the **ENTER** button. The Reset screen appears.
2. Enter the your Security password. This is the password you entered if you set up a BD or DVD Parental rating (See page 36). If you did not, enter 0000.

Network Services

3. After a few moments, Smart Hub automatically resets. The screen may go black, then Smart Hub re-appears. In a few moments, it starts the re-initialization procedure.
4. To complete the re-initialization, go to Step 4 in Starting Smart Hub for the First Time. (See page 49)



NOTE

- If you forgot your password, press the **STOP** (■) button on the front panel of the player for more than 5 seconds with no disc inserted.

Properties

The Properties menu item lists three functions that display information about Smart Hub :

Detail

Lists information about Smart Hub including version number, the number of services installed, memory usage, and the unique product ID.

Check the speed of your internet connection

Runs a test which shows how fast your Internet connection to the Samsung's server is in Mbps (Megabits per second).

Speeds lower than 1.5 Mbps can limit your enjoyment of Smart Hub.

Terms of Service Agreement

Displays the Terms of Service Agreement.

The Edit Mode Menu - YELLOW (C)

The functions in the Edit Mode menu let you manipulate the widgets in the My Applications section of the Smart Hub screen. Using these functions, you can lock and unlock access to some widgets, New Folders and move widgets to them, rename folders, delete widgets, and change the position of widgets on the screen.

To access the Edit Mode Menu, and then select a menu item, follow these steps:

1. Press the **YELLOW (C)** button on your remote. The Edit Mode menu bar appears on the bottom of the screen.

2. Press the **▲▼◀▶** to select a menu item, and then press the **ENTER** button.

The functions in the Edit Mode Menu bar are described below.



NOTE

- Some menu items may not appear on the screen. To see these items, press the **◀▶** to move to the screen edge, and then press one more time to reveal the items.
- You can close the bar by highlighting the X on the bottom right side, and then pressing the **ENTER** button.

Move

The Move function lets you change the screen position of a widget. To use the Move function, follow these steps:

1. Press the **YELLOW (C)** button on your remote.
2. Select a widget, and then press the **ENTER** button. A check appears above the widget.
3. Press the **▲▼◀▶** to select **Move**, and then press the **ENTER** button. A position change icon appears above the widget.
4. Press the **▲▼◀▶** to move the icon. Press the **ENTER** button when the icon is in the position of your choice. The widget moves to its new location.

Move to Folder

The Move to Folder function lets you move a widget to a folder. To use the Move to Folder function, follow these steps:

1. Press the **YELLOW (C)** button on your remote.
2. Select a widget, and then press the **ENTER** button. If you already create a folder, the widget can be moved.
3. Press the **▲▼◀▶** to select Move to Folder, and then press the **ENTER** button. The Move to Folder window opens.
4. Press the **▲▼◀▶** to select a folder, and then press the **ENTER** button. The Moved to Folder message appears, and then closes. The widget has been moved to the folder.

To Access Widgets in a Folder

1. Close the Edit Mode menu.
2. In My Applications, press the **▲▼◀▶** to select a folder, and then press the **ENTER** button. The folder opens.
3. Select a widget, and then press the **ENTER** button. The widget's application or service starts.

To Edit Items in a Folder

Select a folder, and then press the **ENTER** button. The folder opens.

Press the **YELLOW (C)** button on your remote. The Edit buttons appear at the bottom of the screen.

These buttons work the same as the Edit Mode menu buttons on the main screen. For example, to move a widget back to the My Applications main screen:

1. Select the widget.
2. Select Move to Folder, and then press the **ENTER** button. The Move to Folder window appears.
3. Select My Applications, and then press the **ENTER** button. The Move to Folder window closes and the widget returns to the main My Applications screen.

New Folder

The New Folder function lets you create and name new folders. Once you have created a folder, you can move widgets into it. To use the New Folder function, follow these steps:

1. Press the **YELLOW (C)** button on your remote.
2. Press the **▲▼◀▶** to move the cursor to New Folder, and then press the **ENTER** button. The New Folder window and a keypad appear.
3. Use the keypad to enter the name of the folder, and then press the **ENTER** button. The New Folder screen closes and the New Folder appears on the Smart Hub screen.

Rename Folder

The Rename Folder function lets you rename folders. To use the Rename Folder function, follow these steps:

1. Press the **YELLOW (C)** button on your remote.
2. Press the **▲▼◀▶** to select a folder, and then press the **ENTER** button.
3. Press the **▲▼◀▶** to select Rename a Folder, and then press the **ENTER** button. The Folder Rename window and a keypad appears.
4. Use the keypad to enter a new name, and then press the **ENTER** button. The Rename window closes and the new name appears below the folder.

Lock

The Lock function lets you lock some widgets in My Applications so they can not be opened without entering the Parental Security Code.

To use the Lock function, follow these steps:

1. Press the **YELLOW (C)** button on your remote.
2. Press the **▲▼◀▶** to select a widget, and then press the **ENTER** button. If the widget can be locked, the Lock menu item is enabled.
3. Press the **▲▼◀▶** to select Lock, and then press the **ENTER** button. The Lock Service window appears.
4. Enter your Parental Security Code (See page 36). If you have not created a Parental Security Code, enter 0000.
5. Press the **ENTER** button. The Lock Service window appears confirming the lock, and then closes. A lock symbol appears next to the widget.

Network Services

Unlock

1. Press the **YELLOW (C)** button on your remote.
2. Press the **▲▼◀▶** to select a locked widget, and then press the **ENTER** button.
3. Press the **▲▼◀▶** to select Unlock, and then press the **ENTER** button. The Lock Service window appears.
4. Enter the Parental Security Code (See page 36). If you have not created a Parental Security Code, enter 0000.
5. Press the **ENTER** button. The Lock Service Released window appears confirming the lock has been release, and then closes.

Delete

The Delete function lets you delete widgets from My Applications. To use the Delete function, follow these steps:

1. Press the **YELLOW (C)** button on your remote.
2. Press the **▲▼◀▶** to select a widget, and then press the **ENTER** button.
3. Press the **▲▼◀▶** to select Delete, and then press the **ENTER** button. The message, "Do you want to delete selected item(s)?" appears.
4. Select **Yes**, and then press the **ENTER** button. The widget is deleted.

The Sort Menu - GREEN (B)

The functions in the Sort Menu let you sort the widgets in My Applications by Name, Date, Frequency (of use), and Category. If you manually change the position of a widget, the Sort Menu automatically highlights User Defined when you start it.

To sort the widgets in My Applications, follow these steps:

1. Press the **GREEN (B)** button on your remote.
2. Press the **◀▶** to select a sorting method, and then press the **ENTER** button. Smart Hub sorts the widgets by the method you have chosen.

Samsung Apps

Samsung Apps lets you download for pay or free-of-charge applications and services to your Blu-ray Disc player and view or use them on your TV.

These applications and services include videos, music, photos, games, news, sports, etc. Widgets for the new apps appear in My Applications.

Additional applications and services are added regularly.

For Pay Apps

To download for pay apps, you need to create a Samsung Apps account and add a credit card to the account.

To create a Samsung Apps account, please visit www.samsung.com.

NOTE

- This service may not provided in some countries.

Accessing the Samsung Apps Screen

To access Samsung Apps, press the **▲▼◀▶** buttons to navigate to the Samsung Apps area on the Smart Hub main screen, and then press the **ENTER** button. The Samsung Apps screen appears.

NOTE

- If this is the first time you are accessing this screen, the terms of service window appears. If you want to agree, select Agree, and then press the ENTER button.

Using the Samsung Apps Screen

To use the Samsung Apps screen, follow these steps:

1. Press the ◀▶ buttons to move to the category list on the left.
2. Press the ▲▼ to highlight a category. In a few seconds, the Samsung Apps screen displays the applications in that category. The Sort tabs appear across the top.
3. Press the ▶ button to move to the displayed applications or services.
4. Press the ▲▼◀▶ buttons to select an application or service, and then press the **ENTER** button. The Application Details screen appears describing the service or application.
5. Select Download Now, and then press the **ENTER** button. If the application or service is free, it downloads and runs. If not, and there is a fee, follow the directions on the screen to complete the download.



NOTE

- Some apps are free to download, but require registration with the provider or a paid account with the provider to use.
- Widgets for applications and services you have downloaded from Samsung Apps appear in My Applications.

Sort By Tabs

You can access the Sort By tabs on the top of the screen using the ▲▼◀▶ buttons. Each tab displays the services or applications in the category you chose, sorted by the criteria on the tab (Recommended, Most Downloaded, Most Recent, Name).

You can also use the **BLUE (D)** button on your remote to access the Sort By tabs. Each time you press the **BLUE (D)** button, you change the display from one sort tab to the next.

Samsung Apps by category

The following categories are available:

- **What's New?** : Displays newly registered applications.
- **Video** : Displays various video media such as movies, TV shows, and short length videos.
- **Game** : Displays various games such as sudoku and chess.
- **Sports** : Displays various sports media services such as match information, images, and short length videos.
- **Lifestyle** : Includes various lifestyle media services such as music, personal photo management tools, and social networking such as Facebook and Twitter.
- **Information** : Includes various information services such as news, stocks, and weather.
- **Other** : Includes other miscellaneous services.

My Account

My Account gives you access to your Samsung Apps order and download history, and to the My Apps Cash screen. You must have a Samsung Apps account to access this information.

Help

If you have questions about Samsung Apps, check Help first. If none of the tips apply, please visit the www.samsung.com.

To use the Help function, follow these steps:

1. Press the ▲▼◀▶ buttons to select Help, and then press the **ENTER** button.
2. Press the ▲▼ to scroll the Help text.
3. Press the ◀ to exit Help.

Network Services

Using the colored buttons on your remote with Samsung Apps

- **RED (A) (Login)** : To log into your Smart TV Account.
- **GREEN (B) (Thumbnail View/List View)** : To toggle applications between Thumbnail and List view.
- **BLUE (D) (Sort By)** : To sort the applications in a category by Recommended, Most Downloaded, Most Recent, or Name.
- **Return** : To return to the previous menu.

NOTE

- The Internet contents services may be added or deleted by providers without notice.

For instruction to use Your Video or Search Function, please visit www.samsung.com.

BD-LIVE™

Once the player is connected to the network, you can enjoy various movie-related service contents using a BD-LIVE compliant disc.

1. Attach a USB memory stick to the USB jack on the side of the player, and then check its remaining memory. The memory device must have at least 1GB of free space to accommodate the BD-LIVE services.
2. Insert a Blu-ray Disc that supports BD-LIVE.
3. Select an item from various BD-LIVE service contents provided by the disc manufacturer.

NOTE

- The way you use BD-LIVE and the provided contents may differ, depending on the disc manufacturer.

Using the AllShare Function

AllShare lets you play music, video, and photo files located in your PC or your DLNA compatible mobile phone or NAS on the player.

To use AllShare with your player, you must connect the player to your network (See pages 22~23).

To use AllShare with your PC, you must install AllShare software on your PC.

If you have a DLNA compatible mobile phone or NAS, you can use AllShare without any additional software.

You can download the PC software and get detailed instructions for using AllShare from the Samsung.com web site.

Appendix

Troubleshooting

Before requesting service, please check the following.

PROBLEM	SOLUTION
No operation can be performed with the remote control.	<ul style="list-style-type: none">• Check the batteries in the remote control. They may need replacing.• Operate the remote control at a distance of no more than 20 feet.• Remove batteries and hold down one or more buttons for several minutes to drain the microprocessor inside the remote control to reset it. Reinstall batteries and try to operate the remote control again.
Disc does not play.	<ul style="list-style-type: none">• Ensure that the disc is installed with the label side facing up.• Check the region number of the Blu-ray Disc/DVD.
Disc Menu does not appear.	<ul style="list-style-type: none">• Ensure that the disc has disc menus.
The prohibition message appears on the screen.	<ul style="list-style-type: none">• This message appears when an invalid button is pressed.• The Blu-ray Disc/DVD's software doesn't support the feature (e.g., angles).• You've requested a title or chapter number or search time that is out of range.
Play mode differs from the Setup Menu selection.	<ul style="list-style-type: none">• Some of the functions selected in the Setup Menu may not work properly if the disc is not encoded with the corresponding function.
The screen ratio cannot be changed.	<ul style="list-style-type: none">• The Screen Ratio is fixed on your Blu-ray Disc/DVD.• This is not a problem with the player.
No audio.	<ul style="list-style-type: none">• Make sure you have selected the correct Digital Output in the Audio Options Menu.
The screen is blocked	<ul style="list-style-type: none">• If the HDMI output is set to a resolution your TV cannot support (for example, 1080p), you may not see a picture on your TV.• Press the STOP () button (on front panel) for more than 5 seconds with no disc inside. All settings will revert to the factory settings.• When the factory default settings are restored, all stored user BD data is deleted.

Appendix

PROBLEM	SOLUTION
Forgot password	<ul style="list-style-type: none"> • Press the STOP () button (on front panel) for more than 5 seconds with no disc inside. All settings including the password will revert to the factory settings. Don't use this unless absolutely necessary. • When the factory default settings are restored, all stored user BD data is deleted.
If you experience other problems.	<ul style="list-style-type: none"> • Go to the contents and find the section of the user manual that contains the explanations regarding the current problem, and follow the procedure once again. • If the problem still cannot be solved, please contact your nearest Samsung authorized service center.
The picture is noisy or distorted	<ul style="list-style-type: none"> • Make sure that the disc is not dirty or scratched. • Clean the disc.
No HDMI output.	<ul style="list-style-type: none"> • Check the connection between the TV and the HDMI jack of the player. • Check if your TV supports 480p, 720p, 1080i, 1080p HDMI input resolution.
Abnormal HDMI output screen.	<ul style="list-style-type: none"> • If random noise appears on the screen, it means that TV does not support HDCP (High-bandwidth Digital Content Protection).
AllShare function	
I can see folders shared through AllShare, but I cannot see the files.	<ul style="list-style-type: none"> • AllShares shows only files corresponding to the Image, Music, and Movie categories. Files that do not correspond to these categories may not be displayed.
Video is played intermittently.	<ul style="list-style-type: none"> • Check if the network is stable. • Check if the network cable is properly connected and if the network is not overloaded. • The wireless connection between the DLNA compatible device and the player is unstable. Check the connection.
AllShare connection between TV and PC is unstable.	<ul style="list-style-type: none"> • The IP address under the same subnetwork should be unique. If they are not, IP interference can cause this phenomenon. • Check if you have a firewall enabled. If so, disable the firewall function.

PROBLEM	SOLUTION
BD-LIVE	
I cannot connect to the BD-LIVE server.	<ul style="list-style-type: none"> • Check whether the network connection is successful or not by using the Network Status menu. (See page 34) • Check whether the USB memory device is connected to the player. • The memory device must have at least 1GB of free space to accommodate the BD-LIVE service. You can check the available size in BD Data Management. (See page 35) • Check whether the BD-LIVE Internet Connection menu is set to Allow(All). • If all above fails, contact the contents provider or update the player to the latest firmware.
When using the BD-LIVE service, an error occurs.	<ul style="list-style-type: none"> • The memory device must have at least 1GB of free space to accommodate the BD-LIVE service. You can check the available size in BD Data Management. (See page 35)

**NOTE**

- When the factory default settings are restored, all stored user BD data is deleted.

Repairs

If you contact us to repair your player, an administration fee may be charged if either:

1. An engineer is called out to your home at your request and there is no defect in the product.
2. You bring the unit to a repair center and there is no defect in the product.

We will provide you with the amount of the administration fee before we make a home visit or begin any work on your player.

We recommend you read this manually thoroughly, search for a solution on line at www.samsung.com, or contact Samsung Customer Care at 1-800-SAMSUNG (726-7864) before seeking to repair your player.

Dispose unwanted electronics through an approved recycler. To find the nearest recycling location, go to our website : www.samsung.com/recyclingdirect Or call, (877) 578 - 0799.

Appendix

Index

A	
Accessories	14
AllShare	58
Anynet+ (HDMI-CEC)	35
Audio Language	43~44
B	
Background Music	47
BD Data Management	35
BD-LIVE	35, 58
BD Wise	26
BONUSVIEW	44
C	
Camera Angle	44
Contact Samsung	39
D	
Digital Output	28~30
Disc Menu	40
Disc Structure	40
Disc Types	10~12
Downmixing Mode	30
Dynamic Range Control	30
H	
HDMI Deep Color	28
I	
Initial Settings	35
J	
JPEG	47
K	
Keypad	51
M	
Movie Frame (24Fs)	28
MP3	45~46
N	
Network Settings	31~35
P	
PCM Downsampling	30
Popup Menu	41
Progressive Mode	28
R	
Region Code	12
Remote Control	17
Remote Control Sensor	15
Resolution	26~27
S	
Samsung Apps	56~58
Slide Show	47
Smart Hub	49~56
Software Upgrade	37~39
Subtitle Language	44
T	
Title Menu	41
TV Aspect	26
U	
USB Storage Device	48
W	
Wired Network	31~32
Wireless Network	32~34
Z	
Zoom	47

Specifications

General	Power Requirements	AC 120V, 60Hz
	Power Consumption	19W
	Weight	3.7 lbs
	Dimensions	17.0 (W) X 8.1 (D) X 1.7 (H) inches
	Operating Temperature Range	+41°F to +95°F
	Operating Humidity Range	10 % to 75 %
Disc	BD (Blu-ray Disc)	Reading Speed : 9.834 m/sec
	DVD (Digital Versatile Disc)	Reading Speed : 6.98 ~ 7.68 m/sec Approx. Play Time (Single Sided, Single Layer Disc) : 135 min.
	CD : 5 inches (COMPACT DISC)	Reading Speed : 4.8 ~ 5.6 m/sec. Maximum Play Time : 74 min.
	CD : 3 1/2 inches (COMPACT DISC)	Reading Speed : 4.8 ~ 5.6 m/sec. Maximum Play Time : 20 min.
Video Output	Composite Video	1 Channel : 1.0 Vp-p (75Ω load) Blu-ray Disc/DVDs : 480i
Video/Audio	HDMI	1080p, 1080i, 720p, 480p PCM multichannel audio, Bitstream audio
Audio Output	2 Channel	L(1/L), R(2/R)
	Digital Audio Output	Optical
	*Frequency Response	48 kHz Sampling : 4 Hz to 22 kHz 96 kHz Sampling : 4 Hz to 44 kHz
	*S/N Ratio	110 dB
	*Dynamic Range	100 dB
	*Total Harmonic Distortion	0.003%
Network	Ethernet	10/100BASE-TX Terminal
	Wireless LAN	Supports when the player is connected with the Samsung Wireless LAN Adapter. (Model Name : WIS09ABGN)
	Security	WEP (OPEN/SHARED) WPA-PSK (TKIP/AES) WPA2-PSK (TKIP/AES)
	WPS(PBC)	Supported

*: Nominal specification

- Design and specifications are subject to change without prior notice.
- Weight and dimensions are approximate.

Appendix

Compliance and Compatibility Notice

NOT ALL discs are compatible

- Subject to the restrictions described below and those noted throughout this Manual, including the Disc Type and Characteristics section of this user manual, disc types that can be played are: pre-recorded commercial BD-ROM, DVD-VIDEO, and Audio CD (CD-DA) discs; BD-RE/-R, DVD-RW/-R discs; and CD-RW/-R discs.
- Discs other than the above cannot and/or is not intended to be played by this player. And some of the above discs may not play due to one or more reasons provided below.
- Samsung cannot assure that this player will play every disc bearing the BD-ROM, BD-RE/-R, DVD-VIDEO, DVD-RW/-R, DVD+RW/+R and CD-RW/-R logos, and this player may not respond to all operating commands or operate all features of every disc. These and other disc compatibility and player operation issues with new and existing format discs are possible because:
 - Blu-ray is a new and evolving format and this player may not operate all features of Blu-ray Discs because some features may be optional, additional features may have been added to the Blu-ray Disc format after the production of this player, and certain available features may be subject to delayed availability;
 - not all new and existing disc format versions are supported by this player;
 - new and existing disc formats may be revised, changed, updated, improved and/or supplemented;
 - some discs are produced in a manner that allows specific or limited operation and feature during playback;
 - some features may be optional, additional features may have been added after the production of this player or certain available features may be subject to delayed availability;
 - some discs bearing the BD-ROM, BD-RE/-R, DVD-VIDEO, DVD-RW/-R, DVD+RW/+R and CD-RW/-R logos may still be non-standardized discs;
 - some discs may not be played depending on their physical state or recording conditions;
 - problems and errors can occur during the creation of Blu-ray Disc, DVD software and/or the manufacture of discs;
 - this player operates differently than a standard DVD player or other AV equipment; and/or
 - for reasons noted throughout this user manual and for other reason(s) discovered and posted by SAMSUNG customer care center.
- If you encounter disc compatibility or player operation problems, please contact SAMSUNG customer care center.
You may also contact SAMSUNG customer care center for possible updates on this player.
- For additional information on playback restrictions and disc compatibility, refer to the Precautions, Before Reading the user manual, Disc Types and Characteristics, and Before Playing sections of this user manual.

Copy Protection

- Because AAC (Advanced Access Content System) is approved as content protection system for Blu-ray Disc format, similar to use of CSS (Content Scramble System) for DVD format, certain restrictions are imposed on playback, analog signal output, etc., of AAC protected contents. The operation of this product and restrictions on this product may vary depending on your time of purchase as those restrictions may be adopted and/or changed by AAC after the production of this product. Furthermore, BD-ROM Mark and BD+ are additionally used as content protection system for Blu-ray Disc format, which imposes certain restrictions including playback restrictions for BD-ROM Mark and/or BD+ protected contents. To obtain additional information on AAC, BD-ROM Mark, BD+, or this product, please contact SAMSUNG customer care center.

- Many Blu-ray Disc/DVDs are encoded with copy protection. Because of this, you should only connect your Player directly to your TV, not to a VCR. Connecting to a VCR results in a distorted picture from copy-protected Blu-ray Disc/DVDs.
- This item incorporates copy protection technology that is protected by U.S. patents and other intellectual property rights of Rovi Corporation. Reverse engineering and disassembly are prohibited.
- Under the U.S. Copyright laws and Copyright laws of other countries, unauthorized recording, use, display, distribution, or revision of television programs, videotapes, Blu-ray Discs, DVDs, and other materials may subject you to civil and/or criminal liability.
- **For Blu-ray Disc Player progressive scan output** : CONSUMERS SHOULD NOTE THAT NOT ALL HIGH DEFINITION TELEVISION SETS ARE FULLY COMPATIBLE WITH THIS PRODUCT AND MAY CAUSE ARTIFACTS TO BE DISPLAYED IN THE PICTURE. IN CASE OF PROGRESSIVE SCAN PICTURE PROBLEMS, IT IS RECOMMENDED THAT THE USER SWITCH THE CONNECTION TO THE 'STANDARD DEFINITION' OUTPUT. IF THERE ARE QUESTIONS REGARDING OUR TV SET COMPATIBILITY WITH THIS PRODUCT, PLEASE CONTACT OUR CUSTOMER SERVICE CENTER.

Network Service Disclaimer

All content and services accessible through this device belong to third parties and are protected by copyright, patent, trademark and/or other intellectual property laws. Such content and services are provided solely for your personal noncommercial use. You may not use any content or services in a manner that has not been authorized by the content owner or service provider. Without limiting the foregoing, unless expressly authorized by the applicable content owner or service provider, you may not modify, copy, republish, upload, post, transmit, translate, sell, create derivative works, exploit, or distribute in any manner or medium any content or services displayed through this device.

THIRD PARTY CONTENT AND SERVICES ARE PROVIDED "AS IS." SAMSUNG DOES NOT WARRANT CONTENT OR SERVICES SO PROVIDED, EITHER EXPRESSLY OR IMPLIEDLY, FOR ANY PURPOSE. SAMSUNG EXPRESSLY DISCLAIMS ANY IMPLIED WARRANTIES, INCLUDING BUT NOT LIMITED TO, WARRANTIES OF MERCHANTABILITY OR FITNESS FOR A PARTICULAR PURPOSE. SAMSUNG DOES NOT GUARANTEE THE ACCURACY, VALIDITY, TIMELINESS, LEGALITY, OR COMPLETENESS OF ANY CONTENT OR SERVICE MADE AVAILABLE THROUGH THIS DEVICE AND UNDER NO CIRCUMSTANCES, INCLUDING NEGLIGENCE, SHALL SAMSUNG BE LIABLE, WHETHER IN CONTRACT OR TORT, FOR ANY DIRECT, INDIRECT, INCIDENTAL, SPECIAL OR CONSEQUENTIAL DAMAGES, ATTORNEY FEES, EXPENSES, OR ANY OTHER DAMAGES ARISING OUT OF, OR IN CONNECTION WITH, ANY INFORMATION CONTAINED IN, OR AS A RESULT OF THE USE OF ANY CONTENT OR SERVICE BY YOU OR ANY THIRD PARTY, EVEN IF ADVISED OF THE POSSIBILITY OF SUCH DAMAGES.

Third party services may be terminated or interrupted at any time, and Samsung makes no representation or warranty that any content or service will remain available for any period of time. Content and services are transmitted by third parties by means of networks and transmission facilities over which Samsung has no control. Without limiting the generality of this disclaimer, Samsung expressly disclaims any responsibility or liability for any interruption or suspension of any content or service made available through this device.

Samsung is neither responsible nor liable for customer service related to the content and services. Any question or request for service relating to the content or services should be made directly to the respective content and service providers.

Appendix

License

- Manufactured under license from Dolby Laboratories. Dolby and the double-D symbol are trademarks of Dolby Laboratories.



- Manufactured under license under U.S. Patent #'s : 5,451,942; 5,956,674; 5,974,380; 5,978,762; 6,487,535 & other U.S. and worldwide patents issued & pending. DTS and the Symbol are registered trademarks & DTS 2.0+ Digital Out and the DTS logos are trademarks of DTS, Inc. Product includes software. © DTS, Inc. All Rights Reserved.



- DivX

- ABOUT DIVX VIDEO : DivX® is a digital video format created by DivX, Inc. This is an official DivX Certified® device that plays DivX video.



Visit www.divx.com for more information and software tools to convert your files into DivX video.

- ABOUT DIVX VIDEO-ON-DEMAND : This DivX Certified® device must be registered in order to play purchased DivX Video-on-Demand (VOD) movies. To obtain your registration code, locate the DivX VOD section in your device setup menu. Go to vod.divx.com for more information on how to complete your registration.

- DivX Certified® to play DivX® video up to HD 1080p, including premium content.

- DivX®, DivX Certified® and associated logos are trademarks of DivX, Inc. and are used under license.

- Covered by one or more of the following U.S. patents : 7,295,673; 7,460,668; 7,515,710; 7,519,274.

- The terms HDMI and HDMI High-Definition Multimedia Interface, and the HDMI Logo are trademarks or registered trademarks of HDMI Licensing LLC in the United States and other countries.



- Oracle and Java are registered trademarks of Oracle and/or its affiliates. Other names may be trademarks of their respective owners



- This license is limited to private non-commercial use by end-user consumers for licensed contents.

No rights are granted for commercial use. The license does not cover any product unit other than this product unit and the license does not extend to any unlicensed product unit or process conforming to ISO/IEC 11172-3 or ISO/IEC 13818-3 used or sold in combination with this product unit.

The license only covers the use of this product unit to encode and/or decode audio files conforming to the ISO/IEC 11172-3 or ISO/IEC 13818-3. No rights are granted under this license for product features or functions that do not conform to the ISO/IEC 11172-3 or ISO/IEC 13818-3.

- Open Source License Notice

- In the case of using open source software, Open Source Licenses are available on the product menu.

- Blu-ray Disc™, Blu-ray™ and the logos are trademarks of the Blu-ray Disc Association.

- This item incorporates copy protection technology that is protected by U.S. patents and other intellectual property rights of Rovi Corporation. Reverse engineering and disassembly are prohibited.

LIMITED WARRANTY TO ORIGINAL PURCHASER

This SAMSUNG brand product, as supplied and distributed by SAMSUNG and delivered new, in the original carton to the original consumer purchaser, is warranted by SAMSUNG against manufacturing defects in materials and workmanship for a limited warranty period of:

One (1) Year Parts and Labor* (*90 Days Parts and Labor for Commercial Use)

This limited warranty begins on the original date of purchase, and is valid only on products purchased and used in the United States. To receive warranty service, the purchaser must contact SAMSUNG for problem determination and service procedures. Warranty service can only be performed by a SAMSUNG authorized service center. The original dated bill of sale must be presented upon request as proof of purchase to SAMSUNG or SAMSUNG's authorized service center. Transportation of the product to and from the service center is the responsibility of the purchaser.

SAMSUNG will repair or replace this product, at our option and at no charge as stipulated herein, with new or reconditioned parts or products if found to be defective during the limited warranty period specified above. All replaced parts and products become the property of SAMSUNG and must be returned to SAMSUNG. Replacement parts and products assume the remaining original warranty, or ninety (90) days, whichever is longer.

SAMSUNG's obligations with respect to software products distributed by SAMSUNG under the SAMSUNG brand name are set forth in the applicable end user license agreement. Non-SAMSUNG hardware and software products, if provided, are on an "AS IS" basis.

Non-SAMSUNG manufacturers, suppliers, publishers, and service providers may provide their own warranties.

This limited warranty covers manufacturing defects in materials and workmanship encountered in normal, and except to the extent otherwise expressly provided for in this statement, noncommercial use of this product, and shall not apply to the following, including, but not limited to: damage which occurs in shipment; delivery and installation; applications and uses for which this product was not intended; altered product or serial numbers; cosmetic damage or exterior finish; accidents, abuse, neglect, fire, water, lightning or other acts of nature; use of products, equipment, systems, utilities, services, parts, supplies, accessories, applications, installations, repairs, external wiring or connectors not supplied and authorized by SAMSUNG, or which damage this product or result in service problems; incorrect electrical line voltage, fluctuations and surges; customer adjustments and failure to follow operating instructions, cleaning, maintenance and environmental instructions that are covered and prescribed in the instruction book; product removal or reinstallation; reception problems and distortion related to noise, echo, interference or other signal transmission and delivery problems. SAMSUNG does not warrant uninterrupted or error-free operation of the product.

THERE ARE NO EXPRESS WARRANTIES OTHER THAN THOSE LISTED AND DESCRIBED ABOVE, AND NO WARRANTIES WHETHER EXPRESS OR IMPLIED, INCLUDING, BUT NOT LIMITED TO, ANY IMPLIED WARRANTIES OF MERCHANTABILITY OR FITNESS FOR A PARTICULAR PURPOSE, SHALL APPLY AFTER THE EXPRESS WARRANTY PERIODS STATED ABOVE, AND NO OTHER EXPRESS WARRANTY OR GUARANTY GIVEN BY ANY PERSON, FIRM OR CORPORATION WITH RESPECT TO THIS PRODUCT SHALL BE BINDING ON SAMSUNG. SAMSUNG SHALL NOT BE LIABLE FOR LOSS OF REVENUE OR PROFITS, FAILURE TO REALIZE SAVINGS OR OTHER BENEFITS, OR ANY OTHER SPECIAL, INCIDENTAL OR CONSEQUENTIAL DAMAGES CAUSED BY THE USE, MISUSE OR INABILITY TO USE THIS PRODUCT, REGARDLESS OF THE LEGAL THEORY ON WHICH THE CLAIM IS BASED, AND EVEN IF SAMSUNG HAS BEEN ADVISED OF THE POSSIBILITY OF SUCH DAMAGES. NOR SHALL RECOVERY OF ANY KIND AGAINST SAMSUNG BE GREATER IN AMOUNT THAN THE PURCHASE PRICE OF THE PRODUCT SOLD BY SAMSUNG AND CAUSING THE ALLEGED DAMAGE. WITHOUT LIMITING THE FOREGOING, PURCHASER ASSUMES ALL RISK AND LIABILITY FOR LOSS, DAMAGE OR INJURY TO PURCHASER AND PURCHASER'S PROPERTY AND TO OTHERS AND THEIR PROPERTY ARISING OUT OF THE USE, MISUSE OR INABILITY TO USE THIS PRODUCT SOLD BY SAMSUNG NOT CAUSED DIRECTLY BY THE NEGLIGENCE OF SAMSUNG. THIS LIMITED WARRANTY SHALL NOT EXTEND TO ANYONE OTHER THAN THE ORIGINAL PURCHASER OF THIS PRODUCT, IS NONTRANSFERABLE AND STATES YOUR EXCLUSIVE REMEDY.

Some states do not allow limitations on how long an implied warranty lasts, or the exclusion or limitation of incidental or consequential damages, so the above limitations or exclusions may not apply to you. This warranty gives you specific legal rights, and you may also have other rights which vary from state to state.

To obtain warranty service, please contact SAMSUNG customer care center.

Contact SAMSUNG WORLD WIDE

If you have any questions or comments relating to Samsung products, please contact the SAMSUNG customer care center.

Area	Contact Center ☎	Web Site
■ North America		
Canada	1-800-SAMSUNG (726-7864)	www.samsung.com
Mexico	01-800-SAMSUNG (726-7864)	www.samsung.com
U.S.A	1-800-SAMSUNG (726-7864)	www.samsung.com
■ Latin America		
Argentina	0800-333-3733	www.samsung.com
Brazil	0800-124-421 / 4004-0000	www.samsung.com
Chile	800-SAMSUNG (726-7864)	www.samsung.com
Colombia	01-8000112112	www.samsung.com
Costa Rica	0-800-507-7267	www.samsung.com
Dominica	1-800-751-2676	www.samsung.com
Ecuador	1-800-10-7267	www.samsung.com
El Salvador	800-6225	www.samsung.com
Guatemala	1-800-299-0013	www.samsung.com
Honduras	800-7919267	www.samsung.com
Jamaica	1-800-234-7267	www.samsung.com
Nicaragua	00-1800-5077267	www.samsung.com
Panama	800-7267	www.samsung.com
Peru	0-800-777-08	www.samsung.com
Puerto Rico	1-800-682-3180	www.samsung.com
Trinidad & Tobago	1-800-SAMSUNG (726-7864)	www.samsung.com
Venezuela	0-800-100-5303	www.samsung.com
■ Europe		
Albania	42 27 5755	-
Austria	0810 - SAMSUNG (7267864, € 0.07/min)	www.samsung.com
Belgium	02-201-24-18	www.samsung.com/ be (Dutch) www.samsung.com/ be_fr (French)
Bosnia	05 133 1999	-
Bulgaria	07001 33 11	www.samsung.com
Croatia	062 SAMSUNG (062 726 7864)	www.samsung.com
Czech	800-SAMSUNG (800-726786) Samsung Zrt., česká organizační složka, Oasis Florenc, Sokolovská394/17, 180 00, Praha 8	www.samsung.com
Denmark	70 70 19 70	www.samsung.com
Finland	030 - 6227 515	www.samsung.com
France	01 48 63 00 00	www.samsung.com
Germany	01805 - SAMSUNG (726-7864 € 0,14/Min)	www.samsung.com
Hungary	06-80-SAMSUNG (726-7864)	www.samsung.com
Italia	800-SAMSUNG (726-7864)	www.samsung.com
Kosovo	+381 0113216899	-
Luxemburg	261 03 710	www.samsung.com
Macedonia	023 207 777	-
Montenegro	020 405 888	-
Netherlands	0900-SAMSUNG (0900-7267864) (€ 0,10/Min)	www.samsung.com
Norway	815-56 480	www.samsung.com
Poland	0 801 1SAMSUNG (172678) / 022-607-93-33	www.samsung.com
Portugal	80820-SAMSUNG (726-7864)	www.samsung.com
Rumania	1. 08010 SAMSUNG (72678) - doar din rețeaua Romtelecom, tarif local 2. 021.206.01.10 - din orice rețea, tarif normal	www.samsung.com

Area	Contact Center ☎	Web Site
Serbia	0700 Samsung (0700 726 7864)	www.samsung.com
Slovakia	0800-SAMSUNG (726-7864)	www.samsung.com
Spain	902-1-SAMSUNG (902 172 678)	www.samsung.com
Sweden	0771 726 7864 (SAMSUNG)	www.samsung.com
Switzerland	0848-SAMSUNG (7267864, CHF 0.08/min)	www.samsung.com/ch www.samsung.com/ ch_fr(French)
U.K	0330 SAMSUNG (7267864)	www.samsung.com
Eire	0818 717100	www.samsung.com
Lithuania	8-800-77777	www.samsung.com
Latvia	8000-7267	www.samsung.com
Estonia	800-7267	www.samsung.com
■ CIS		
Russia	8-800-555-55-55	www.samsung.com
Georgia	8-800-555-555	-
Armenia	0-800-05-555	-
Azerbaijan	088-55-55-555	-
Kazakhstan	8-10-800-500-55-500 (GSM: 7799)	www.samsung.com
Uzbekistan	8-10-800-500-55-500	www.samsung.com
Kyrgyzstan	00-800-500-55-500	www.samsung.com
Tadjikistan	8-10-800-500-55-500	www.samsung.com
Ukraine	0-800-502-000	www.samsung.ua www.samsung.com/ ua_ru
Belarus	810-800-500-55-500	-
Moldova	00-800-500-55-500	-
■ Asia Pacific		
Australia	1300 362 603	www.samsung.com
New Zealand	0800 SAMSUNG (0800 726 786)	www.samsung.com
China	400-810-5858 / 010-6475 1880	www.samsung.com
Hong Kong	(852) 3698 4698	www.samsung.com/hk www.samsung.com/ hk_en/
India	3030 8282 / 1800 110011 / 1800 3000 8282 / 1800 266 8282	www.samsung.com
Indonesia	0800-112-8888 / 021-5699-7777	www.samsung.com
Japan	0120-327-527	www.samsung.com
Malaysia	1800-88-9999	www.samsung.com
Philippines	1-800-10-SAMSUNG(726-7864) / 1-800-3-SAMSUNG(726-7864) / 1-800-8-SAMSUNG(726-7864) / 02-5805777	www.samsung.com
Singapore	1800-SAMSUNG (726-7864)	www.samsung.com
Thailand	1800-29-3232 / 02-689-3232	www.samsung.com
Taiwan	0800-329-999	www.samsung.com
Vietnam	1 800 588 889	www.samsung.com
■ Middle East		
Bahrain	8000-4726	www.samsung.com
Egypt	08000-726786	www.samsung.com
Jordan	800-22273	www.samsung.com
Morocco	080 100 2255	www.samsung.com
Oman	800-SAMSUNG (726-7864)	www.samsung.com
Saudi Arabia	9200-21230	www.samsung.com
Turkey	444 77 11	www.samsung.com
U.A.E	800-SAMSUNG (726-7864)	www.samsung.com
■ Africa		
Nigeria	0800-SAMSUNG (726-7864)	www.samsung.com
South Africa	0860-SAMSUNG (726-7864)	www.samsung.com

English

Cinavia Notice : This product uses Cinavia technology to limit the use of unauthorized copies of some commercially-produced film and videos and their soundtracks. When a prohibited use of an unauthorized copy is detected, a message will be displayed and playback or copying will be interrupted.

More information about Cinavia technology is provided at the Cinavia Online Consumer Information Center at <http://www.cinavia.com>. To request additional information about Cinavia by mail, send a postcard with your mailing address to: Cinavia Consumer Information Center, P.O. Box 86851, San Diego, CA, 92138, USA.

This product incorporates proprietary technology under license from Verance Corporation and is protected by U.S. Patent 7,369,677 and other U.S. and worldwide patents issued and pending as well as copyright and trade secret protection for certain aspects of such technology. Cinavia is a trademark of Verance Corporation. Copyright 2004 - 2010 Verance Corporation. All rights reserved by Verance. Reverse engineering or disassembly is prohibited.

Français

Avis Cinavia : Ce produit utilise la technologie Cinavia pour limiter l'utilisation de copies illégales de certains films et vidéos disponibles dans le commerce et de leur bande sonore. Lorsqu'une utilisation illégale ou une reproduction interdite est détectée, un message s'affiche et la lecture ou la reproduction s'interrompt. De plus amples renseignements sur la technologie Cinavia sont disponibles auprès du Centre d'information des consommateurs en ligne de Cinavia sur <http://www.cinavia.com>. Pour obtenir des renseignements supplémentaires par la poste sur Cinavia, envoyez votre demande avec votre adresse au : Cinavia Consumer Information Center, P.O. Box 86851, San Diego, CA, 92138, USA.

Ce produit intègre une technologie sous licence de Verance Corporation protégée par le brevet américain 7,369,677 et d'autres brevets américains et internationaux déposés ou en attente, de même que par des droits d'auteur et le secret industriel pour certains aspects de cette technologie. Cinavia est une marque de commerce de Verance Corporation. Copyright 2004-2010 Verance Corporation.

Tous droits réservés par Verance. Il est interdit de tenter de démonter l'appareil et d'en étudier le fonctionnement en vue de le reproduire.

Español

Aviso de Cinavia: Este producto utiliza tecnología Cinavia para limitar el uso de copias no autorizadas de algunas películas de producción comercial, videos y sus bandas sonoras. Cuando se detecta el uso de una copia no autorizada, aparecerá un mensaje y se interrumpirá la reproducción o la copia.

Información adicional sobre la tecnología Cinavia se facilita en el Centro de información al cliente en línea de Cinavia en <http://www.cinavia.com>. Para solicitar información adicional sobre Cinavia por correo, envíe una tarjeta con su dirección postal a: Cinavia Consumer Information Center, P.O. Box 86851, San Diego, CA, 92138, EE.UU.

Este producto incorpora tecnología de propietario bajo licencia de Verance Corporation y está protegido mediante la patente en EE.UU. 7,369,677 y otras patentes en EE.UU. y en otros países pendientes, así como por copyright y la protección de secreto comercial de ciertos aspectos tecnológicos. Cinavia es una marca comercial de Verance Corporation. Copyright 2004-2010 Verance Corporation. Todos los derechos reservados por Verance. La ingeniería inversa o desensamblaje están prohibidos.

Português

Nota da Cinavia: Esse produto usa tecnologia Cinavia para limitar o uso de cópias não autorizadas de filmes e videos produzidos comercialmente e sua trilha sonora. Quando se detecta o uso proibido de uma cópia não autorizada, aparece uma mensagem e a reprodução ou cópia é interrompida.

Há mais informações sobre a tecnologia Cinavia na Central Cinavia on-line de informações ao cliente, em <http://www.cinavia.com>. Para solicitar mais informações sobre a Cinavia pelo correio, envie um cartão postal com seu endereço para: Cinavia Consumer Information Centre, P.O. Box 86851, San Diego, CA, 92138, USA.

Esse produto incorpora tecnologia proprietária sob licença da Verance Corporation e protegida pela Patente 7.369.677 dos EUA e outras patentes nos EUA e no mundo todo, emitidas e pendentes, além de direitos autorais e proteção ao segredo comercial de certos aspectos dessa tecnologia. Cinavia é uma marca registrada da Verance Corporation. Copyright 2004-2010 Verance Corporation. Todos os direitos reservados à Verance. É proibido realizar engenharia reversa ou desmontagem.

Français

Avis de Cinavia : Ce produit utilise la technologie Cinavia pour limiter l'utilisation de copies non autorisées de certains films et vidéos commerciaux ainsi que leurs bandes son. Lorsqu'une copie non autorisée est détectée, un message est affiché et la lecture ou la copie est interrompue. Des informations complémentaires concernant la technologie Cinavia sont disponibles sur le site <http://www.cinavia.com> du Centre d'information consommateur Cinavia. Pour toute demande d'informations complémentaires concernant Cinavia par courrier, veuillez écrire à l'adresse suivante : Cinavia Consumer Information Centre, P.O. Box 86851, San Diego, CA, 92138, USA. Ce produit intègre la technologie de protection de la propriété sous licence Verance Corporation protégée par les brevets américains 7.369.677 et d'autres brevets américains et internationaux accordés et en attente ainsi que la protection des droits d'auteur et de l'information commerciale confidentielle pour certains aspects de cette technologie. Cinavia est une marque commerciale de Verance Corporation. Copyright 2004-2010 Verance Corporation. Tous droits réservés par Verance. Il est interdit de tenter de démonter l'appareil et d'en étudier le fonctionnement en vue de le reproduire.

Italiano

Avvertenza Cinavia : Questo prodotto utilizza tecnologia Cinavia per limitare l'uso di copie non autorizzate di film e video commerciali e relative tracce audio. Se viene rilevato l'uso proibito di una copia non autorizzata, viene visualizzato un messaggio che interrompe la riproduzione o la copia. Per maggiori informazioni sulla tecnologia Cinavia consultare il centro online di informazioni ai consumatori di Cinavia all'indirizzo <http://www.cinavia.com>. Per richiedere maggiori informazioni su Cinavia per e-mail, inviare un messaggio con il proprio indirizzo a: Cinavia Consumer Information Centre, P.O. Box 86851, San Diego, CA, 92138, USA. Questo prodotto è dotato di tecnologia proprietaria di Verance Corporation ed è protetto dal brevetto U.S.A. 7.369.677 e da altri brevetti U.S.A. e di altri Paesi registrati e in attesa di registrazione, di una protezione del copyright e del segreto aziendale per alcuni aspetti di tale tecnologia. Cinavia è un marchio di Verance Corporation. Copyright 2004-2010 Verance Corporation. Verance. Tutti i diritti riservati. Sono vietati il reverse engineering o lo smontaggio.

Português

Aviso Cinavia : Este produto utiliza tecnologia Cinavia para limitar a utilização não autorizada de cópias de alguns filmes e vídeos produzidos comercialmente e respectivas bandas sonoras. Quando a utilização proibida de uma cópia não autorizada é detectada, é apresentada uma mensagem e a reprodução ou cópia é interrompida. Poderá obter mais informações sobre a tecnologia Cinavia no Centro de Informação ao Consumidor Online da Cinavia em <http://www.cinavia.com>. Para solicitar informações adicionais sobre a Cinavia por correio, envie um bilhete postal com a sua morada para: Cinavia Consumer Information Centre, P.O. Box 86851, San Diego, CA, 92138, USA. Este produto incorpora tecnologia proprietária ao abrigo da licença da Verance Corporation e protegida pela patente americana, 7.369.677 e outras patentes dos EUA e de outros países, emitidas ou cuja aprovação esteja pendente, bem com direitos de autor e protecção de segredo comercial para determinados aspectos da tecnologia mencionada. A Cinavia é uma marca comercial da Verance Corporation. Direitos de autor 2004-2010 Verance Corporation. Todos os direitos reservados pela Verance. É proibido qualquer procedimento de desmontagem ou montagem.

Español

Aviso de Cinavia : Este producto utiliza tecnología Cinavia para limitar el uso de copias no autorizadas de algunas películas de producción comercial, videos y sus bandas sonoras. Cuando se detecta el uso de una copia no autorizada, aparecerá un mensaje y se interrumpirá la reproducción o la copia. Información adicional sobre la tecnología Cinavia se facilita en el Centro de información al cliente en línea de Cinavia en <http://www.cinavia.com>. Para solicitar información adicional sobre Cinavia por correo, envíe una tarjeta con su dirección postal a: Cinavia Consumer Information Center, P.O. Box 86851, San Diego, CA, 92138, EE.UU. Este producto incorpora tecnología de propietario bajo licencia de Verance Corporation y está protegido mediante la patente en EE.UU. 7.369.677 y otras patentes en EE.UU. y en otros países pendientes, así como por copyright y la protección de secreto comercial de ciertos aspectos tecnológicos. Cinavia es una marca comercial de Verance Corporation. Copyright 2004-2010 Verance Corporation. Todos los derechos reservados por Verance. La ingeniería inversa o desensamblaje están prohibidos.

Nederlands

Opmerking betreffende Cinavia : Dit product maakt gebruik van Cinavia-technologie om het gebruik van illegale exemplaren van sommige commercieel geproduceerde films en video's en de soundtracks ervan te beperken. Wanneer wordt gedetecteerd dat een illegale kopie wordt gebruikt, wordt een bericht weergegeven en zal het afspeLEN van kopieën worden onderbroken. U vindt meer informatie over Cinavia-technologie bij het Cinavia Online Consumer Information Centre op <http://www.cinavia.com>. Als u aanvullende informatie over Cinavia via de post wenst te ontvangen, stuur u een postkaart met uw postadres naar: Cinavia Consumer Information Centre, P.O. Box 86851, San Diego, CA, 92138, USA. Dit product omvat bedrijfseigen technologie onder licentie van de Verance Corporation en wordt beschermd door U.S. Patent 7.369.677 en andere Amerikaanse en internationale patenten die zijn verstrekt of nog in behandeling zijn, naast de bescherming van copyrights en bedrijfsgeheimen voor bepaalde aspecten van dergelijke technologie. Cinavia is een handelsmerk van Verance Corporation. Copyright 2004-2010 Verance Corporation. Alle rechten voorbehouden door Verance. Reverseengineering of demontage is verboden.

Dansk

Bemærkning vedr. Cinavia : Dette produkt anvender Cinavia-teknologi til begrænsning af ikkeautoriseret kopiering af visse kommercielt producerede film og videoer samt deres lydspor. Når forbudt anvendelse af en ikke-autoriseret kopi detekteres, vises en meddelelse, og afspilning eller kopiering bliver afbrudt. Flere informationer om Cinavia-teknologi fås hos Cinavias onlineforbrugerinformationsscenter på <http://www.cinavia.com>. For at få flere informationer om Cinavia pr. post kan du sende et postkort med din postadresse til: Cinavia Consumer Information Centre, P.O. Box 86851, San Diego, CA, 92138, USA. Dette produkt anvender producentsspecifik teknologi under licens fra Verance Corporation og er beskyttet af USA-patent 7.369.677 og andre USA- og verdensomfattende patenter, både allerede udstedte og under ansøgning, samt copyright og beskyttelse af handelshemmeligheder for visse dele af sådan teknologi. Cinavia er et varemærke tilhørende Verance Corporation. Copyright 2004-2010 Verance Corporation. Alle rettigheder forbeholdes Verance. Reverse engineering eller adskillelse er forbudt.

Suomi

Cinavia-ilmoitus: Tämä tuote käyttää Cinavia-tekniikkaa rajoittaakseen joidenkin laupallisesti tuotettujen elokuvien ja videoiden sekä niiden ääniraitojen kappallisten kopioiden käyttöä. Kun luuttoman kopion kielletty käyttö tunnistetaan, viesti tulee näkyviin ja toisto tai kopiointi keskeytetään. Saat lisätietoja Cinavia-tekniikasta Cinavia Online Consumer Information Centre -kuluttajakeskuksesta osoitteessa <http://www.cinavia.com>. Voit pyytää lisätietoja Cinaviasta postitse lähettämällä postikortin, joka sisältää postiosoitteesi, osoitteeseen: Cinavia Consumer Information Centre, P.O. Box 86851, San Diego, CA, 92138, USA.

Tässä tuotteessa käytetään valmistajien tekniikkaa Verance Corporationin lisenssillä. Käyttöä suojaavat USA:n patentin 7,369,677 ja muut USA:n sekä maailmanlaajuiset myönnetyt ja vireillä olevat patentit sekä tiettyjen tekniikan osien tekijänoikeus- ja kauppasalaisuusuojuat. Cinavia on Verance Corporationin tavaramerkki. Copyright 2004-2010 Verance Corporation. Verance pidättää kaikki oikeudet. Käytyn salaustekniikan purkaminen on kielletty.

Norsk

Cinavia-merknad : Dette produktet bruker Cinavia-teknologi for å begrense bruken av uautoriserte kopier av enkelte kommersielt produserte filmer, videoer og deres lydspor. Når det detekteres forbudt bruk av en uautorisert kopi, vises en melding og avspillingen eller kopieringen vil bli avbrutt. Mer informasjon om Cinavia-teknologien finner du hos Cinavias forbrukersenter på <http://www.cinavia.com>. For mer informasjon om Cinavia via regulær post, send et postkort med din postadresse til: Cinavia Consumer Information Centre, P.O. Box 86851, San Diego, CA, 92138, USA. Dette produktet innbefatter proprietær teknologi på lisens fra Verance Corporation og er beskyttet av amerikansk patent 7,369,677 og andre amerikanske og verdensomfattende patenter og patentsøknader, samt beskyttelse av copyright og forretningshemmeligheter for visse aspekter av slik teknologi. Cinavia er et varemerke som tilhører Sony Corporation. Copyright 2004-2010 Verance Corporation. Alle rettigheter forbeholdt for Verance. Omvendt utvikling eller demontering er forbudt.

Svenska

Cinavia-meddelande : Den här produkten använder Cinavia-teknik för att begränsa antalet obehöriga kopior på vissa kommersiellt producerade filmer och videor och deras ljudspår. Om en förbjuden användning av en obehörig kopia upptäcks visas ett meddelande och uppspelningen eller kopieringen avbryts. Mer information om Cinavia-tekniken erbjuds av Cinavia Online Consumer Information Centre på adressen <http://www.cinavia.com>. För att begära ytterligare information om Cinavia via post, skicka ett vykort med din adress till: Cinavia Consumer Information Centre, P.O. Box 86851, San Diego, CA, 92138, USA.

Den här produkten införlivar egendomsteknik på licens från Verance Corporation och skyddas av det amerikanska patentet 7,369,677 och andra patent i USA och internationellt och väntande patent, samt upphovsrätt och varumärkesskydd för vissa delar av sådan teknik. Cinavia är ett varumärke som tillhör Verance Corporation. Upphovsrätt 2004-2010 Verance Corporation. Med ensamrätt för Verance. Reverse engineering och nedmontering är förbjudet.

Česky

Upozornění k technologii Cinavia : Tento přístroj využívá technologii Cinavia k omezení použití neoprávněných kopií některých komerčních filmů a videí a jejich zvukových stop. Při zjištění zakázaného použití neautorizované kopie se zobrazí hlášení a přehrávání nebo kopírování je přerušeno. Další informace o technologii Cinavia naleznete v Online středisku informací pro spotřebitele na webu <http://www.cinavia.com>. Další informace o technologii Cinavia si můžete vyžádat také poštou. Pošlete svou korespondenční adresu na adresu: Cinavia Consumer Information Centre, P.O. Box 86851, San Diego, CA, 92138, USA.

Tento přístroj využívá proprietární technologii licencovanou společností Verance Corporation a je chráněn patentem USA č. 7 369 677 a dalšími vydanými a přihlášenými patenty ve Spojených státech amerických a dalších zemích. Na některé aspekty této technologie se také vztahuje ochrana autorských práv a obchodního tajemství. Cinavia je ochranná známka společnosti Verance Corporation. Copyright 2004-2010 Verance Corporation. Všechna práva vyhrazena společností Verance. Zpětná analýza a převod do strojového kódu jsou zakázány.

Deutsch

Cinavia Hinweise : Dieses Gerät nutzt die Cinavia Technologie um die Erstellung illegaler Kopien kommerziell produzierter Filme und Videos sowie deren Soundtracks zu verhindern. Wenn die verbotene Nutzung einer illegalen Kopie festgestellt wird, erscheint eine Meldung und die Wiedergabe bzw. der Kopiervorgang werden abgebrochen. Mehr Informationen über die Cinavia Technologie finden Sie im Online Kundeninformationszentrum unter <http://www.cinavia.com>. Wenn Sie zusätzliche Informationen über Cinavia über E-Mail erhalten möchten, senden Sie bitte eine Postkarte mit Ihrer E-Mail Adresse an: Cinavia Consumer Information Centre, P.O. Box 86851, San Diego, CA, 92138, USA.

Dieses Gerät nutzt geschützte Technologie unter der Lizenz von Verance Corporation und ist durch das U.S. Patent 7.369.677 und andere in der USA und weltweit ausgestellten & angemeldeten Patenten sowie durch die Urheberrechte und die Sicherung von Betriebsgeheimnissen bestimmter Aspekte dieser Technologie geschützt. Cinavia ist eine Handelsmarke von Verance Corporation. Copyright 2004-2010 Verance Corporation. Alle Rechte vorbehalten für Verance Reverse Engineering oder Demontage sind verboten.

Magyar

Cinavia figyelmeztetés : A készülék a Cinavia technológiáját használja a kereskedelmi forgalomban lévő filmek és videók, valamint hangsvájalk illetéktelen másolásának megakadályozására. Ha illetéktelen másolat tiltott használatát érzékeli, a készülék megjelenít egy üzenetet, és a lejátszás vagy másolás félbeszakad.

A Cinavia technológiáról további információkat a Cinavia Online ügyfélszolgálaton kaphat a <http://www.cinavia.com> címen. További információk a Cinaviáról postai úton küldjön egy levelezőlapot a postacímével a következő címre: Cinavia Consumer Information Centre, P.O. Box 86851, San Diego, CA, 92138, USA.

A termék egy szerzői jogvédelmi technológiát alkalmaz, mely eljárás a Verance Corporation birtokos, és az USA-ban bejegyzett 7,369,677 számú szabadalom, illetve más, és az USA-ban és máshol bejegyzett szabadalmak és szerzői jogok védenek, és az ilyen technológiákra vonatkozó kereskedelmi titkok. A Cinavia a Verance Corporation védjegye. Copyright 2004-2010 Verance Corporation. A Verance minden jogot fenntart. A rendszer visszafejtése vagy visszafordítása tilos.

Polski

Komentarz Cinavia : Urządzenie to korzysta z technologii Cinavia w celu ograniczenia wykorzystania nieupoważnionych kopii pewnych filmów i obrazów video wyprodukowanych w celach komercyjnych, oraz ich ścieżek dźwiękowych. W przypadku wykrycia zakazanego użycia nieautoryzowanej kopii, zostanie wyświetlony komunikat i proces odtwarzania i kopiowania zostanie zatrzymany. Więcej informacji o technologii Cinavia można uzyskać w Centrum obsługi klienta Cinavia online: <http://www.cinavia.com>. Aby poprosić o przesłanie dodatkowych informacji o Cinavia pocztą, wyslij kartkę ze swoim adresem pocztowym na adres: Centrum informacji konsumenta Cinavia, P.O. Box 86851, San Diego, CA, 92138, USA. Urządzenie to zostało wyprodukowane z zastosowaniem technologii własnościowej na licencji firmy Verance Corporation, i jest chronione amerykańskim patentem 7,369,677 oraz innymi patentami Stanów Zjednoczonych i innych krajów, wydanymi i wydawanymi, oraz prawami autorskimi, a także chroniony tajemnicą handlową obejmującą określone aspekty takiej technologii. Cinavia jest znakiem towarowym firmy Verance Corporation. Copyright 2004–2010 Verance Corporation. Wszystkie prawa zastrzeżone przez firmę Verance. Niedozwolone jest odtwarzanie wsteczne (ang. reverse engineering) i rozmontowywanie urządzenia.

Slovensky

Upozornenie na technologii Cinavia : Tento výrobok využíva technológiu Cinavia na obmedzenie používania neoprávnených kópií niektorých komerčne vyrábaných filmov a videí a ich zvukových záznamov. Keď sa zistí, že došlo k zakázanému použitiu neoprávnenej kópie, zobrazí sa správa a prehrávanie alebo kopírovanie sa preruší. Viac informácií o technológii Cinavia nájdete na on-line informačnom centre pre spotrebiteľov Cinavia na lokalite <http://www.cinavia.com>. Ak chcete požiadať o zaslanie ďalších informácií o technológii Cinavia poštou, zašlite list s vašou poštovou adresou na adresu: Cinavia Consumer Information Centre, P.O. Box 86851, San Diego, CA, 92138, USA. Tento výrobok obsahuje súkromnú technológiu na základe licencie od spoločnosti Verance Corporation, ktorá je chránená americkým patentom č. 7 369 677 a ďalšími patentmi a patentovými prihláškami v USA a na celom svete, pričom niektoré aspekty tejto technológie podliehajú aj ochrane autorským právam a ochrane obchodného tajomstva. Cinavia je obchodná značka spoločnosti Verance Corporation. Autorské práva 2004 - 2010 Verance Corporation. Spoločnosť Verance si vyhradzuje všetky práva. Spätná analýza alebo prevod do strojového kódu sú zakázané.

Slovenščina

Obvestilo o tehnologiji Cinavia: Ta izdelek uporablja tehnologijo Cinavia za omejitve uporabe nepooblaščenih kopij nekaterih komercialno posnetih filmov in videoposnetkov ter njihovih zvočnih posnetkov. Kadar naprava zazna uporabo nepooblaščenih kopije, se bo prikazalo sporočilo in predvajanje ali kopiranje se bo prekinilo. Več informacij o tehnologiji Cinavia najdete v spletnem informacijskem središču za stranke Cinavia na <http://www.cinavia.com>. Če želite prejeti dodatne informacije o tehnologiji Cinavia po pošti, nam pošljite svoj domači naslov na: Cinavia Consumer Information Centre, P.O. Box 86851, San Diego, CA, 92138, USA. Ta izdelek vsebuje lastniško tehnologijo z licenco družbe Verance Corporation in je zaščiten z ameriškim patentom 7,369,677 ter drugimi izdanji ali vloženi ameriški in svetovni patenti, kot tudi z zakoni o varstvu pravic in nerazkrivanju poslovnih skrivnosti za določene vidike takšne tehnologije. Cinavia je blagovna znamka družbe Verance Corporation. Avtorske pravice 2004-2010 Verance Corporation. Vse pravice si pridržuje družba Verance. Obratno inženirstvo in razstavljanje sta prepovedana.

Български

Бележка за Cinavia : Този продукт използва технологията Cinavia, за да ограничи използването на неоторизирани копия на някои филми, видеоклипове и саундтраци. Когато се засече забранено ползване на неоторизирано копие, ще се покаже съобщение и възпроизвеждането или копирането ще се прекъсне. Повече информация за технологията Cinavia се предоставя от онлайн центъра за информация за клиенти на Cinavia на <http://www.cinavia.com>. За да поискате допълнителна информация от Cinavia по пощата, изпратете запитванията с вашия пощенски адрес на: Cinavia Consumer Information Centre, P.O. Box 86851, San Diego, CA, 92138, USA. Този продукт използва фирмена технология под лиценз от Verance Corporation и е защитен с патент на САЩ 7,369,677 и други издани и заявени патенти в САЩ и по целия свят, както и от защита на авторското право и търговските тайни за определени аспекти от такава технология. Cinavia е търговска марка на Verance Corporation. Copyright 2004–2010 Verance Corporation. Всички права запазени от Verance. Забранен е инжениринг или демонтиране в обратен ред.

Română

Notă din partea Cinavia : Acest aparat utilizează tehnologie Cinavia pentru a limita utilizarea unor copii neautorizate ale unor filme sau materiale video produse spre comercializare, precum și a coloanelor sonore asociate acestora. Dacă este detectată utilizarea ilegală sa unei copii neautorizate, va fi afișat un mesaj și redarea sau copierea este întreruptă. Pentru informații suplimentare despre tehnologia Cinavia, consultați Centrul online de informații pentru consumatori Cinavia, la adresa <http://www.cinavia.com>. Pentru a solicita prin poștă informații suplimentare despre Cinavia, trimiteți un plic timbrat cu adresa dvs. la: Cinavia Consumer Information Centre, P.O. Box 86851, San Diego, CA, 92138, USA. Acest aparat încorporează tehnologie de proprietate sub licență de la Verance Corporation și este protejat de către brevetul SUA 7.369.677 și de către alte brevete din SUA și din întreaga lume emise și în curs de emitere, precum și de către legea drepturilor de autor și a secretului comercial privind anumite aspecte ale acestei tehnologii. Cinavia este o marcă comercială a Verance Corporation. Copyright 2004-2010 Verance Corporation. Toate drepturile sunt rezervate de Verance. Este interzisă demontarea sau dezasamblarea produsului.

Ελληνικά

Είδοποίηση τεχνολογίας Cinavia : Αυτό το προϊόν χρησιμοποιεί τεχνολογία Cinavia για τον περιορισμό της χρήσης μη εξουσιοδοτημένων αντιγράφων ορισμένων ταινιών και βίντεο που διατίθενται στο εμπόριο, καθώς και της ηχητικής επένδυσής τους. Αν ανιχνευτεί απαγορευμένη χρήση ενός μη εξουσιοδοτημένου αντιγράφου, εμφανίζεται ένα μήνυμα και διακόπτεται η αναπαραγωγή ή αντιγραφή. Περισσότερες πληροφορίες για την τεχνολογία Cinavia παρέχονται στο Διαικτικό κέντρο πληροφοριών πελατών της Cinavia, στη διεύθυνση <http://www.cinavia.com>. Για να ζητήσετε πρόσθετες πληροφορίες σχετικά με την τεχνολογία Cinavia μέσω ταχυδρομείου, στείλετε μια κάρτα με την ταχυδρομική διεύθυνσή σας στο: Cinavia Consumer Information Centre, P.O. Box 86851, San Diego, CA, 92138, USA. Το προϊόν αυτό ανωματίζεται αποκλειστική τεχνολογία που χρησιμοποιείται κατόπιν αδειάς από τη Verance Corporation, η οποία προστατεύεται από το δίπλωμα ευρεσιτεχνίας Η.Π.Α. με αριθμό 7.369.677 και άλλα δίπλωματα ευρεσιτεχνίας που έχουν εκδοθεί και εκκρεμούν στις Η.Π.Α. και διεθνώς, καθώς και από προστασία πνευματικών δικαιωμάτων και εμπορικών μυστικών για ορισμένα στοιχεία της συγκεκριμένης τεχνολογίας. Η επωνυμία Cinavia είναι εμπορικό σήμα της Verance Corporation. Πνευματικά δικαιώματα 2004-2010 Verance Corporation. Με την επιφύλαξη παντός δικαιώματος από τη Verance. Απαγορεύεται η αποσυμπίληση ή ανακατασκευή κώδικα.

Hrvatski

Obavijest o tehnologiji Cinavia : ovaj proizvod rabi tehnologiju Cinavia kako bi se ograničila uporaba neovlaštenih kopija nekih komercijalno proizvedenih filmova i videozapisa i njihovih zvučnih zapisa. Kada se otkrije zabranjena uporaba neovlaštene kopije, prikazat će se poruka i prekinut će se reproduciranje i kopiranje. Ostale informacije o tehnologiji Cinavia dostupne su u mrežnom informacijskom centru za korisnike tvrtke Cinavia na <http://www.cinavia.com>. Kako biste zatražili dodatne informacije o tehnologiji Cinavia putem pošte, pošaljite nam dopis na poštansku adresu: Cinavia Consumer Information Centre, P.O. Box 86851, San Diego, CA, 92138, SAD.

Ovaj proizvod sadržava zakonom zaštićenu tehnologiju pod licencom korporacije Verance i zaštićen je američkim patentom 7,369,677 i ostalim američkim i svjetskim patentima koji su izdanje i čije je izdanje u tijeku, kao i zaštitama autorskih prava i poslovnih tajni za određene aspekte te tehnologije. Cinavia je zaštitni znak korporacije Verance. Autorsko pravo 2004-2010 Verance Corporation. Sva prava pridržava Verance. Zabranjeni su obrnuti inženjering i rastavljanje.

Srpski

Cinavia obavještenje : Ovaj proizvod koristi Cinavia tehnologiju za ograničenje upotrebe neovlašćenih kopija nekih komercijalno proizvedenih filmova i video zapisa i zvučnih zapisa. Kada se otkrije upotreba neovlašćene kopije, prikazaće se poruka i reprodukcija ili kopiranje će biti prekinuto. Više informacija o Cinavia tehnologija dostupne su na internet informacionom centru za potrošače Cinavia na adresi <http://www.cinavia.com>. Da biste zatražili dodatne informacije o Cinavia- i putem pošte, pošaljite razglednicu sa vaše e-adrese: Cinavia Consumer Information Centre, P.O. Box 86851, San Diego, CA, 92138, SAD. Ovaj proizvod sadrži tehnologiju u vlasništvu pod licencom kompanije Verance Corporation i zaštićen je američkim patentom 7,369,677 i drugim američkim i svjetskim patentima koji su potvrđeni ili su na čekanju, kao i zaštitom autorskih prava i poslovne tajne za određene aspekte takve tehnologije. Cinavia je zaštitni znak kompanije Verance Corporation. Copyright 2004-2010 Verance Corporation. Sva prava zadržana od strane kompanije Verance. Reinženjering ili demontaža su zabranjeni.

Қазақша

Cinavia ескертуі : Бұл өнімде коммерциялық фильм мен бейнелердің және олардың саунд-тректерінің рұқсатсыз көшірмелерін шектеу үшін Cinavia технологиясы пайдаланылады. Пайдалануға тыйым салынған рұқсатсыз көшірмені пайдалану анықталса, хабар көрсетіледі және ойнату немесе көшіру үзіледі. Cinavia технологиясы туралы қосымша ақпарат <http://www.cinavia.com> торабындағы Cinavia желілік тұтынушылар туралы ақпарат орталығында берілген. Cinavia туралы қосымша ақпаратты пошта арқылы сұрау үшін пошта мекенжайыңыз бар ашыққатты мына мекенжайға жіберіңіз : Cinavia Consumer Information Centre, P.O. Box 86851, San Diego, CA, 92138, USA. Бұл Verance корпорациясының лицензиясы бар жекеменшік технологияны қамтиды және АҚШ-тың 7,369,677 патентімен, ері шығарылған және кутудегі басқа АҚШ және дүниежүзілік патенттермен, сондай-ақ, авторлық құқықтармен және осындай технологияның белгілі бір жақтарын құпия қорғаныспен қорғалған. Cinavia – Verance корпорациясының сауда белгісі. Авторлық құқықтар, 2004-2010 Verance корпорациясы. Барлық құқықтар Verance корпорациясымен қорғалған. Кері жобалауға және бөлшектеуге тыйым салынады.

Русский

Уведомление о Cinavia: Данный продукт оснащен технологией Cinavia, которая не позволяет использовать незаконно сделанные копии серийно изготавливаемых записей фильмов и видео, а также музыки из этих фильмов и видео. В случае обнаружения использования незаконно сделанной копии на экране появится соответствующее сообщение, и процесс воспроизведения или копирования будет прерван. Дополнительные сведения о технологии Cinavia представлены на сайте Центра информации для потребителей Cinavia по адресу: <http://www.cinavia.com>. Чтобы запросить дополнительные сведения о технологии Cinavia по почте, отправьте нам открытку с вашим почтовым адресом: Cinavia Consumer Information Centre, P.O. Box 86851, San Diego, CA, 92138, USA. Данный продукт оснащен запатентованной технологией с лицензией от Verance Corporation и защищенной патентом США 7,369,677 и другими патентами США и международными патентами, изданными и рассматриваемыми, а определенные аспекты этой технологии – авторскими правами и охраной секретов производства. Cinavia является товарным знаком корпорации Verance Corporation. Verance Corporation, 2004-2010 гг. Все права защищены корпорацией Verance. Инженерный анализ и разборка запрещены.

Українська

Заявлення щодо Cinavia: у цьому продукті використовується технологія Cinavia, що обмежує використання несанкціонованих копій деяких комерційних кінофільмів і відеозаписів, а також використаних у них звукових доріжок. У разі виявлення забороненого використання несанкціонованої копії, відобразиться відповідне повідомлення, а відтворення або копіювання буде призупинено. Додаткові відомості про технологію Cinavia можна знайти в Інформаційному онлайн-центрі Cinavia за веб-адресою <http://www.cinavia.com>. Щоб надіслати запит на отримання додаткової інформації про Cinavia поштою, надішліть поштовою листівку зі своєю поштовою адресою на таку адресу: Cinavia Consumer Information Centre, P.O. Box 86851, San Diego, CA, 92138, USA. У цьому продукті використано запатентовану технологію, ліцензовану компанією Verance Corporation і захищену патентом США 7 369 677 та іншими всісвітніми патентами, виданими та такими, що очікують затвердження, а також авторським правом і принципами охорони таємниць виробництва певних аспектів цієї технології. Cinavia є торговельною маркою Verance Corporation. Авторське право належить корпорації Verance Corporation, 2004-2010 рр. Усі права належать корпорації Verance. Забороняється вносити зміни до конструкції продукту або розбирати його.

繁體中文

Cinavia 聲明：本產品使用 Cinavia 技術來限制使用某些商業製造的電影和視頻及其聲道的未經授權副本。當偵測到禁止使用的未經授權副本時，將會顯示一則訊息，並且播放或複製動作將會中斷。

Cinavia 技術的詳細資訊在 Cinavia 線上消費者資訊中心中提供。網址為：<http://www.cinavia.com>。若要透過郵件請寄關於 Cinavia

的其他資訊，請將含有您的郵寄地址的明信片寄往：Cinavia Consumer Information Centre, P.O. Box 86851, San Diego, CA, 92138, USA.

本產品融合了在獲得 Verance Corporation 許可並且受美國專利 7,369,677 以及其他在蓋和世界各地已公布和正在申請的專利保護，並且受此類技術特定方面的版權和商業秘密保護。

Cinavia 是 Verance Corporation 的商標。2004-2010 Verance Corporation 版權所有。Verance 保留一切權利。嚴禁進行逆向工程和反匯編。

中國語

Cinavia 聲明：本產品使用 Cinavia 技術來限制使用一些商業製造的電影和視頻及其聲道的未經授權的副本。檢測到禁止使用未經授權的副本的情況時，將會顯示消息，並且播放或複製將會中斷。

有關 Cinavia 技術的更多信息，在 Cinavia 在消費者資訊中心提供。網址如下：<http://www.cinavia.com>。要通過郵件請求關於 Cinavia

的更多信息，請將含有您的郵寄地址的明信片寄往：Cinavia Consumer Information Centre, P.O. Box 86851, San Diego, CA, 92138, USA.

本產品融合了在獲得 Verance Corporation 許可並且受美國專利 7,369,677 以及其他在蓋和世界各地已公布和正在申請的專利保護，並且受此類技術特定方面的版權和商業秘密保護。

Cinavia 是 Verance Corporation 的商標。2004-2010 Verance Corporation 版權所有。Verance 保留一切權利。嚴禁進行逆向工程和反匯編。

עברית

משתמש זה הוא Cinavia: על עגונב העדוה יתלב טיקורטבה שמישה תא ליבגהל ידכ Cinavia טיגולונכט והזוי ראשכ. מהלש לוקה יספו תירחסמ הקפהב מיטרס לש מייקוח או הלפעה לכו העדוה רכ לע גצות, יקוח יתלב קתועב רוסא שומיש וקספו הקתעה

עדימה זכרמב אוצמל ותינ Cinavia טיגולונכט תודוא סוסו עדימ תרבותכ טע היולג חלש, ראודב Cinavia תודוא סוסו עדימ תלבלק לל: Cinavia Consumer Information Centre, P.O. Box 86851, San Diego, CA, 92138, USA.

דיגאת מעטמ תינינק תחת טיגולונכט בלשמ זה רזומ Verance טיטוטו 7,369,677 יאקראמ טוטט די לע וגומ אוהו Verance מיטלוה טידמוע טהש או ולבתקהש מירחא מימלועו מיאקראמי טיבה רבע ירחסמ תודוסו מירצוי תיונכ לע נגה די לע סג ומ, דיגאת לש ירחסמ ולמס אוהו Cinavia. זוכ הטיגולונכט לש מימוסמ Verance. לל דיגאת 2004 - 2010 מירצוי תיונכ. Verance-ל תרומש תיונכ או רוחאל הסדנה עצבל רוסיא חל Verance-ל תרומש קורפו.

Thai**ประกาศเกี่ยวกับ Cinavia :**

ผลิตภัณฑ์นี้เทคโนโลยี Cinavia เพื่อจำกัดการใช้งานแผ่นที่ไม่ได้รับอนุญาตของฟิล์มและวีดีโอและแทรกเสียงที่ผลิตภัณฑ์เพื่อการค่างานแผ่น เมื่อพบการใช้งานต้องห้ามของแผ่นที่ไม่ได้รับอนุญาต ข้อความจะปรากฏขึ้นและการเล่นหรือการคัดลอกจะหยุดทำงาน

ข้อมูลเพิ่มเติมเกี่ยวกับเทคโนโลยี Cinavia มีให้ที่ศูนย์ข้อมูลลูกค้าทางออนไลน์ของ Cinavia ที่ <http://www.cinavia.com> หากต้องการขอรับข้อมูลเพิ่มเติมเกี่ยวกับ Cinavia ทางไปรษณีย์ ส่งไปสภารัตที่มีที่อยู่ของคุณไปที่: Cinavia Consumer Information Centre, P.O. Box 86851, San Diego, CA, 92138, USA

ผลิตภัณฑ์นี้รวมเอาเทคโนโลยีเอคสิทธิ์เฉพาะภายใต้การอนุญาตจาก Verance Corporation และได้รับความคุ้มครองโดยสิทธิบัตรสหรัฐฯ เลขที่ 7,369,677 และสิทธิบัตรสหรัฐฯ อื่นๆ และทั่วโลกที่ประกาศแล้วและการพิจารณา รวมทั้งลิขสิทธิ์และการป้องกันความลับทางการค้าในบางด้านของเทคโนโลยีดังกล่าว Cinavia เป็นเครื่องหมายการค้าของ Verance Corporation ลิขสิทธิ์ 2004-2010 Verance Corporation สงวนลิขสิทธิ์ทั้งหมดโดย Verance ห้ามดำเนินการทางวิศวกรรมย้อนกลับหรือถอดชิ้นส่วนผลิตภัณฑ์

Türkçe

Cinavia Notice : This product uses Cinavia technology to limit the use of unauthorized copies of some commercially-produced film and videos and their soundtracks. When a prohibited use of an unauthorized copy is detected, a message will be displayed and playback or copying will be interrupted.

More information about Cinavia technology is provided at the Cinavia Online Consumer Information Centre at <http://www.cinavia.com>. To request additional information about Cinavia by mail, send a postcard with your mailing address to: Cinavia Consumer Information Centre, P.O. Box 86851, San Diego, CA, 92138, USA.

This product incorporates proprietary technology under licence from Verance Corporation and is protected by U.S. Patent 7,369,677 and other U.S. and worldwide patents issued and pending as well as copyright and trade secret protection for certain aspects of such technology. Cinavia is a trademark of Verance Corporation. Copyright 2004-2010 Verance Corporation. All rights reserved by Verance. Reverse engineering or disassembly is prohibited.

Indonesia

Pemberitahuan Cinavia : Produk ini menggunakan teknologi Cinavia untuk membatasi penggunaan tanpa izin salinan film dan video tertentu yang diproduksi secara komersial serta soundtraknya. Apabila penggunaan salinan tanpa izin yang dilarang terdeteksi, pesan akan ditampilkan dan pemutaran atau penyalinan akan dihentikan.

Informasi selengkapnya tentang teknologi Cinavia tersedia di Pusat Informasi Pelanggan Online Cinavia di <http://www.cinavia.com>. Untuk meminta informasi tambahan mengenai Cinavia melalui pos, kirimkan kartu pos dengan alamat surat Anda ke: Cinavia Consumer Information Centre, P.O. Box 86851, San Diego, CA, 92138, USA.

Produk ini menerapkan teknologi milik sendiri berdasarkan lisensi dari Verance Corporation dan dilindungi oleh Paten AS 7,369,677 dan paten AS dan di seluruh dunia lainnya yang terdaftar dan dalam pendaftaran, serta perlindungan hak cipta dan rahasia dagang atas aspek tertentu dari teknologi tersebut. Cinavia adalah merek dagang dari Verance Corporation. Hak Cipta 2004-2010 Verance Corporation. Semua hak dimiliki oleh Verance. Rekayasa balik atau pembongkaran dilarang.

Tiếng Việt

Thông báo của Cinavia: Sản phẩm này sử dụng công nghệ Cinavia để hạn chế việc sử dụng các bản sao trái phép một số bộ phim và video được sản xuất thương mại và các đoạn âm thanh của chúng. Khi bị phát hiện sử dụng bản sao trái phép, một thông báo sẽ được hiển thị và việc phát lại hoặc sao chép sẽ bị gián đoạn. Thông tin khác về công nghệ Cinavia được cung cấp tại Trung tâm thông tin dành cho người tiêu dùng trực tuyến Cinavia ở địa chỉ <http://www.cinavia.com>. Để yêu cầu thông tin khác về Cinavia qua thư, hãy gửi một danh thiếp kèm theo địa chỉ nhận thư của bạn đến: Cinavia Consumer Information Centre, P.O. Box 86851, San Diego, CA, 92138, USA.

Sản phẩm này tích hợp công nghệ độc quyền theo giấy phép của Verance Corporation và được bảo hộ bởi Bằng sáng chế Hoa Kỳ 7,369,677 và các bằng sáng chế của Hoa Kỳ và trên toàn thế giới khác đã được cấp và đang chờ cấp cũng như sự bảo vệ bí mật thương mại và bản quyền đối với các khía cạnh cụ thể của công nghệ đó. Cinavia là nhãn hiệu của Verance Corporation. Bản quyền 2004-2010 Verance Corporation. Mọi quyền được bảo lưu bởi Verance. Nghiêm cấm thiết kế đối chiếu và tháo rời sản phẩm.

اللغة العربية

Cinavia : يستخدم هذا المنتج تقنية

للحد من استخدام النسخ غير المرخص بها من بعض الأفلام ومقاطع الفيديو التي يتم إنتاجها للأغراض التجارية ومسارات الصوت المتاحة بها. وعند اكتشاف الاستخدام المحظور

لنسخة غير معتمدة، يتم عرض رسالة وستتم مقاطعة التشغيل أو النسخ.

يتم توفير المزيد من المعلومات حول تقنية Cinavia في مركز معلومات

مستهلك Cinavia على الإنترنت في الموقع

<http://www.cinavia.com>. لطلب المزيد من المعلومات حول

Cinavia عبر البريد، قم بإرسال البطاقات البريدية مع عنوانك البريدي

إلى: Cinavia Consumer Information Centre, P.O. Box 86851

San Diego, CA 92138, USA.

يشتمل هذا المنتج على تقنية مملوكة للشركة بموجب ترخيص من شركة وهي خاضعة لحماية براءة الاختراع الأمريكية Verance Corporation رقم ٧,٣٦٩,٦٧٧ وغيرها من براءات الاختراع الأمريكية والعالمية الأخرى التي تم إصدارها والمعلقة بالإضافة إلى حماية حقوق الطبع والنشر علامة تجارية Cinavia والأسرار التجارية لأوجه معينة لهذه التقنية. تعد حقوق الطبع والنشر للأعوام من Verance Corporation. خاصة لشركة يتم حفظ كل Verance Corporation ٢٠٠٤ إلى ٢٠١٠ محفوظة لشركة يحظر إجراء الهندسة العكسية أو تفكيك هذا Verance الحقوق لصالح المنتج.



QUESTIONS OR COMMENTS?

COUNTRY	CALL	OR VISIT US ONLINE AT	WRITE
IN THE US	1-800-SAMSUNG (726-7864)	www.samsung.com	Samsung Electronics America, Inc. 85 Challenger Road Ridgefield Park, NJ 07660-2112

